

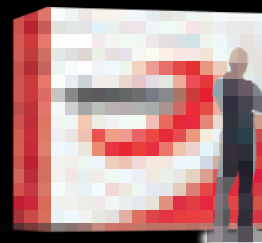

# ***Ejes Homocinéticos y sus Componentes***



Los productos de la marca Transejes® son referentes de calidad diseñados para el mercado de repuestos  
***Transejes® es Calidad de punta a punta***



# Ejes Homocinéticos y sus Componentes

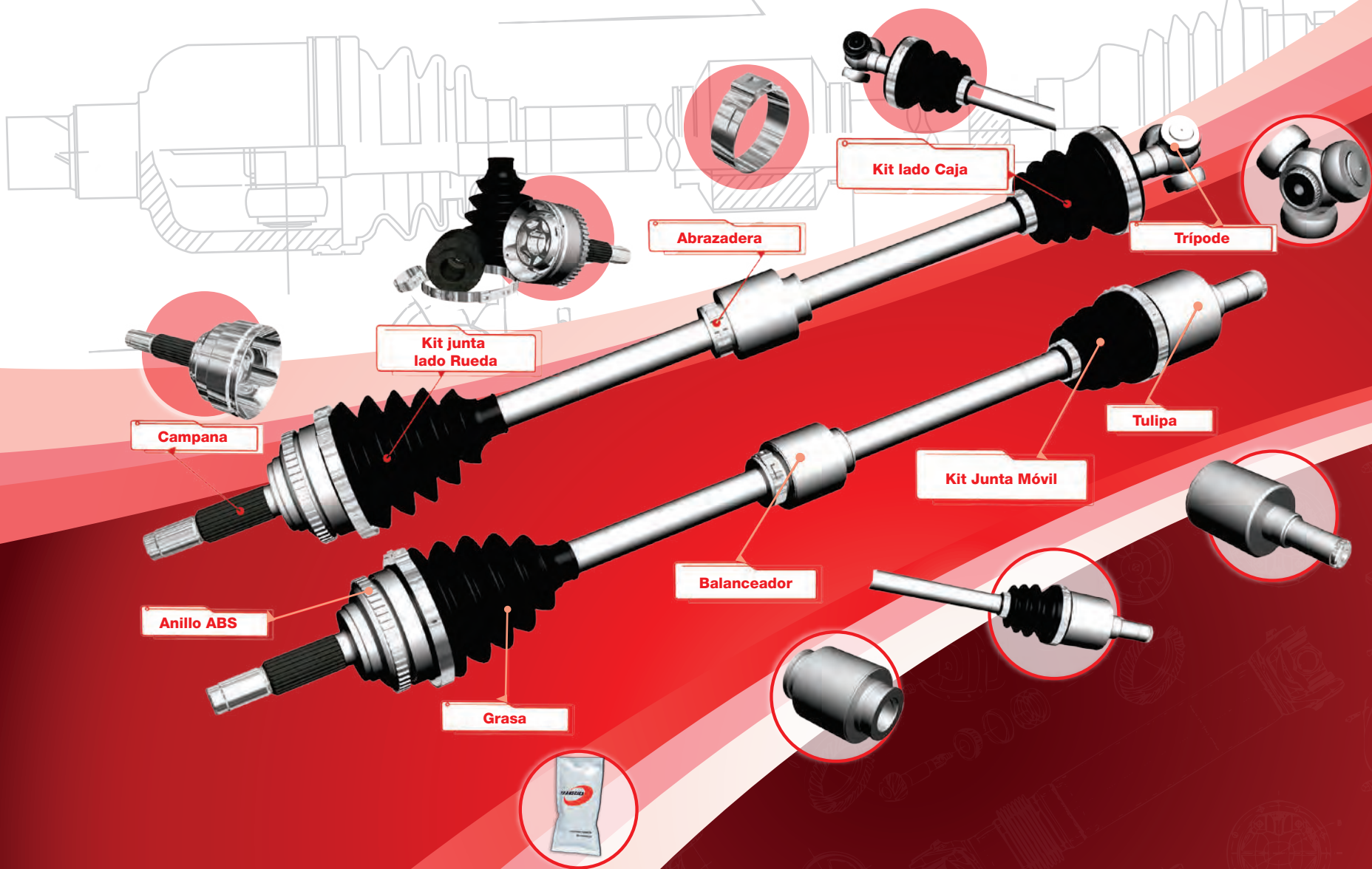

# USO del Catálogo

## Eje Homocinéticos Transejes®

1. La sigla T al inicio, hace referencia a la marca **TRANSEJES®**.
2. Las siguientes siglas hacen referencia al grupo de producto al que pertenece:

- T17:** Eje completo.  
**T12:** Kits junta lado rueda.  
**T16:** Guardapolvos.  
**T14:** kits punta lado caja.  
**T13:** Trípodes o tricetas lado caja.

### CONVENCIONES

Para la identificación técnica de las puntas se tienen las siguientes convenciones:

- A** = Número de estrías espigo, lado Rueda o lado Caja.  
**B** = Número de estrías internas (aplica tanto al lado de la Rueda como al lado de la Caja).  
**C** = Diámetro de asiento de guardapolvo o Retenedor de la junta Lado Rueda o Tulipa Lado Caja.

### EN LOS EJES HOMOCINÉTICOS COMPLETOS

- A** = Número de estrías espigo lado Rueda.  
**B** = Número de estrías espigo lado caja.  
**H** = Longitud espiga.  
**L** = Longitud total del Eje Homocinético.  
**I** = Pinadero interno.  
**M** = Pinadero medio.  
**O** = Pinadero externo.  
**ABS** = Si lleva o no anillo ABS y el número de dientes del mismo.  
**L/R** = Left / Right.  
**F/R0** = Front / Rear.  
**N/A** = No aplica las características.  
**AT** = Automático.  
**MT** = Mecánico.  
**N.D** = No disponible.

### PUNTA LADO RUEDA

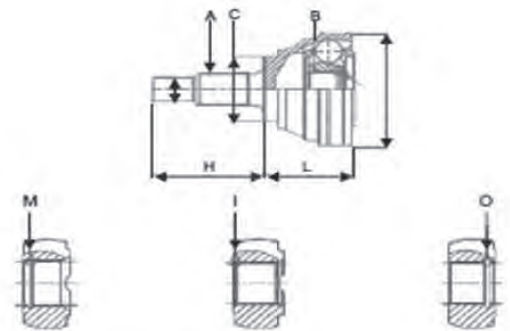

### PUNTA LADO CAJA

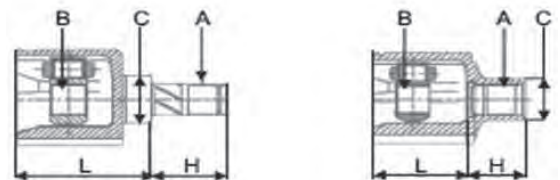

### EJE COMPLETO

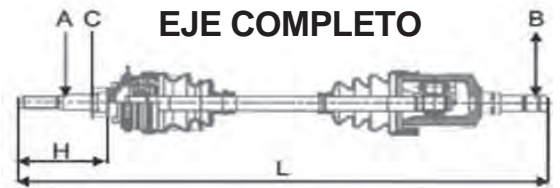

### EJEMPLO :

<b>T</b>	<b>12</b>	<b>0200KX</b>
Marca Transejes	Kit Junta Lado Rueda	Consecutivo



## ¿Por qué elegir Productos Componentes de Ejes Homocinéticos Transejes®?



- Diseño específico para el mercado de repuestos.
- Los Ejes Homocinéticos y sus componentes han sido probados y validados a través de pruebas de calidad y durabilidad efectuadas en vehículos de mayor movilidad, asegurando el correcto funcionamiento y la máxima garantía del producto.
- Precios competitivos.
- Los mejores en su categoría.
- Respaldados por DANA INCORPORATED, un proveedor de confianza. Siéntase confiado de haber seleccionado lo mejor en diseño de repuestos, servicios y valor agregado del mercado.



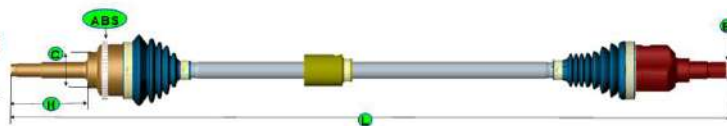

A: # Dientes Exterior Junta Fija Lado Rueda  
 B: # Dientes Exterior Junta Movil O Tulpa Lado Caja Vel  
 C: Diametro Asiento Rodamiento Lado Rueda  
 H: Longitud Estriado Junta Fija Lado Rueda  
 L: Longitud Total Homocinetico Ref.

ABS: # Dientes Disco Freno ABS  
 ATX/AT: Automatico  
 MTX/MT: Mecanico Manual  
 L: Lado Izquierdo (Left)  
 R: Lado Derecho (Right)  
 P: Pinadero  
 O: Externo (Outer)  
 I: Interno (Inner)  
 M: Medio (Middle)

V: 11 22

Audi

Datos del producto						Generales			Características Técnicas					
Marca	# Transejes®	Producto	Año Inicial	Año Final	Modelo	MT/AT	L/R	ABS	A	B	C	H	L	P
Audi	T123662KX	JF Lado Rueda	1996	2003	A3 (8L1) 1.8	MT/AT	L/R	NA	36	30	53	78	60	I

Chery

Datos del producto						Generales			Características Técnicas					
Marca	# Transejes®	Producto	Año Inicial	Año Final	Modelo	MT/AT	L/R	ABS	A	B	C	H	L	P
Chery	T123677KX	JF Lado Rueda	1982	1986	Chery III (N12) 1,5 / 1,7 L	MT/AT	L/R	NA	24	22	52	105	56	I
Chery	T123638KX	JF Lado Rueda	2009	-	Q 1.0	MT	L/R	NA	22	19	51	91	56.5	O
Chery	T123209KX	JF Lado Rueda	2006	-	QQ 0.8 / 1.1	MT	L/R	NA	22	19	51	91	56.5	O
Chery	T140205KX	JM Lado Caja	2006	-	QQ 0.8 / 1.1	MT	L/R	NA	22	19	35	54.5	79	NA
Chery	T175039KX	Eje Homocinetico	2013	-	Chery Van Cargo 1.5	MT	R	43	23	25	51	94	903 / 943	NA
Chery	T123637KX	JF Lado Rueda	2013	-	Chery Yoyo Van 1.2	MT	L/R	43	23	21	51	94	54	I
Chery	T144027KX	JM Lado Caja	2013	-	Chery Yoyo Van 1.2	MT	L/R	NA	25	21	41	50.5	61.5	NA

Chevrolet

Alto

Datos del producto						Generales			Características Técnicas					
Marca	# Transejes®	Producto	Año Inicial	Año Final	Modelo	MT/AT	L/R	ABS	A	B	C	H	L	P
Chevrolet	T123001KX	JF Lado Rueda	2003	-	Alto	MT	L/R	NA	23	19	49	92	56.5	M
Chevrolet	T123013KX	JF Lado Rueda	2003	-	Alto	MT	L/R	NA	23	19	49	78	57	M
Chevrolet	T143025KX	JM Lado Caja	1993	2000	Alto (Suzuki)	MT	L/R	NA	22	19	35	51.9	93.4	NA

Astra

Datos del producto						Generales			Características Técnicas					
Marca	# Transejes®	Producto	Año Inicial	Año Final	Modelo	MT/AT	L/R	ABS	A	B	C	H	L	P
Chevrolet	T120221KX	JF Lado Rueda	1994	1998	Astra F	AT	L/R	NA	22	22	52.2	97	50	O

Aveo

Datos del producto						Generales			Características Técnicas					
Marca	# Transejes®	Producto	Año Inicial	Año Final	Modelo	MT/AT	L/R	ABS	A	B	C	H	L	P
Chevrolet	T120222KX	JF Lado Rueda	2013	2019	New Aveo	MT	L/R	47	22	22	52	95	56.5	M
Chevrolet	T123012KX	JF Lado Rueda	2006	2014	Aveo	MT	L/R	47	22	23	52	96	56	M
Chevrolet	T123622KX	JF Lado Rueda	2006	-	Aveo Korea 22T	MT	L/R	47	22	22	52	96.5	53.5	O
Chevrolet	T123665KX	JF Lado Rueda	2006	-	Aveo	MT	L/R	NA	22	23	52	96	56	M
Chevrolet	T144009KX	JM Lado Caja	2006	-	Aveo	MT/AT	L/R	NA	34	22	35	56.5	69	NA
Chevrolet	T144010KX	JM Lado Caja	2006	-	Aveo 1.6 Emotion	AT	L/R	NA	23	24	42	90	108	NA
Chevrolet	T144057KX	JM Lado Caja	2008	-	Aveo Ckd	AT	L/R	NA	22	22	35	46.5	105	NA
Chevrolet	T170200KX	Eje Homocinetico	2005	-	Aveo	MT	R	47	22	34	52	96.4	923	NA
Chevrolet	T170201KX	Eje Homocinetico	2005	-	Aveo	MT	L	47	22	34	52	96.5	611	NA

Captiva

Datos del producto						Generales			Características Técnicas					
Marca	# Transejes®	Producto	Año Inicial	Año Final	Modelo	MT/AT	L/R	ABS	A	B	C	H	L	P
Chevrolet	T120219KX	JF Lado Rueda	2006	-	Captiva (C100) 3.2	MT	L/R	NA	30	22	-	105.5	53.5	O
Chevrolet	T120225KX	JF Lado Rueda	2009	2011	Captiva/Sport 3.2 - 3.6 Lt	MT/AT	L/R	51	30	36	56	104.5	180	I
Chevrolet	T123672KX	JF Lado Rueda	2007	2021	Captiva 3.0/2.0/2.4/3.2	MT/AT	L/R	NA	30	34	54	105.5	64.5	O
Chevrolet	T144011KX	JM Lado Caja	2007	-	Captiva Mecanica	MT	R	NA	27	25	42	60.5	86	NA
Chevrolet	T144013KX	JM Lado Caja	2003	-	Captiva 2.4 Automatica	AT	R	NA	34	24	35	136.5	79.5	NA
Chevrolet	T144016KX	JM Lado Caja	2003	-	Captiva 2.4 Automatica	AT	L	NA	34	24	34.5	NA	115	NA
Chevrolet	T175019KX	Eje Homocinetico	2007	-	Captiva Mecanica	MT	L/R	NA	30	27	54.4	104.5	548 / 608	NA
Chevrolet	T175021KX	Eje Homocinetico	2003	-	Captiva 2.4	AT	R	NA	30	34	54.4	104.5	660 / 705	NA
Chevrolet	T175023KX	Eje Homocinetico	2003	-	Captiva 2.4	AT	L	NA	30	34	54.4	104.5	568 / 618	NA

Corsa

Datos del producto						Generales			Características Técnicas					
Marca	# Transejes®	Producto	Año Inicial	Año Final	Modelo	MT/AT	L/R	ABS	A	B	C	H	L	P
Chevrolet	T120200KX	JF Lado Rueda	1996	-	Corsa 1.3 Brasil MTX	MT	L/R	NA	22	28	52	97.5	55	O
Chevrolet	T120201KX	JF Lado Rueda	1996	-	Corsa 1.6	MT	L/R	NA	22	22	52	96	56	I
Chevrolet	T120202KX	JF Lado Rueda	1996	-	Corsa 1.3 Andino	MT	L/R	NA	22	30	52	95.5	57.5	O
Chevrolet	T120223KX	JF Lado Rueda	1996	-	Corsa Evolution	MT	L/R	NA	22	22	52.2	97	50	O
Chevrolet	T131844KX	Bota Lado Rueda	1996	-	Corsa	MT	L/R	NA	NA	NA	NA	NA	NA	NA
Chevrolet	T132814KX	Bota Lado Caja	1996	-	Corsa	MT	L/R	NA	NA	NA	NA	NA	NA	NA
Chevrolet	T140206KX	JM Lado Caja	1993	2000	Corsa B (73_ 78_ 79_ F35_)	MT	L/R	NA	22	22	34.95	57.5	72.5	NA
Chevrolet	T143015KX	JM Lado Caja	1996	-	Corsa	MT	L/R	NA	22	28	34.9	57.5	72.5	NA
Chevrolet	T170205KX	Eje Homocinetico	1993	-	Corsa	MT	R	NA	22	22	52	97.5	912 - 967	NA
Chevrolet	T175020KX	Eje Homocinetico	1996	-	Corsa	MT	L	NA	22	22	52.1	97	568 / 610	NA

Cultus

Datos del producto						Generales			Características Técnicas					
Marca	# Transejes®	Producto	Año Inicial	Año Final	Modelo	MT/AT	L/R	ABS	A	B	C	H	L	P
Chevrolet	T143026KX	JM Lado Caja	1994	1999	Cultus (Suzuki)	AT	L/R	NA	26	22	40	54	73	NA

D-Max

Datos del producto						Generales			Características Técnicas					
Marca	# Transejes®	Producto	Año Inicial	Año Final	Modelo	MT/AT	L/R	ABS	A	B	C	H	L	P
Chevrolet	T120209KX	JF Lado Rueda	2002	2014	D-Max 3.0 -Rodeo- Luv 2.2. (Vastago Punta Pin Roscado/ D-Max De Lujo)	MT	L/R	NA	17	33	53	144	69.5	I
Chevrolet	T120218KX	JF Lado Rueda	2004	2012	D-Max 2.5 2010 - D-MaxR T50	MT	L/R	NA	17	33	53	136.5	72.7	I
Chevrolet	T143022KX	JM Lado Caja	2002	-	D-Max	MT	R	NA	17	33	30	97.5	95.5	NA
Chevrolet	T144004KX	JM Lado Caja	2002	-	D-Max 3.0	MT	L/R	NA	17	33	45	97.5	81.5	NA
Chevrolet	T174006KX	Eje Homocinetico	2003	2013	D-Max I 2.5 4X4 Diesel Tapa De Lujo	MT	L/R	NA	17	17	53	144	609 / 664	NA
Chevrolet	T174006KX	Eje Homocinetico	2007	2013	D-Max I 3.0 4X4 Diesel Tapa De Lujo	MT/AT	L/R	NA	17	17	53	144	609 / 664	NA

Epica/Esteem

Datos del producto						Generales			Características Técnicas					
Marca	# Transejes®	Producto	Año Inicial	Año Final	Modelo	MT/AT	L/R	ABS	A	B	C	H	L	P
Chevrolet	T123624KX	JF Lado Rueda	1998	-	Epica	MT	L/R	NA	28	29	55.5	99	61	O
Chevrolet	T120213KX	JF Lado Rueda	1996	-	Esteem 1.6	MT/AT	L/R	NA	25	20	49	76	61	M
Chevrolet	T123003KX	JF Lado Rueda	1996	-	Esteem 1.6/1.8	MT/AT	L/R	NA	25	21	49	76	61	M
Chevrolet	T123006KX	JF Lado Rueda	1996	-	Esteem 1.3	MT	L/R	NA	25	19	49	76	60.5	I
Chevrolet	T123008KX	JF Lado Rueda	1996	-	Esteem 1.6	MT	L/R	NA	25	20	49	76	63	M
Chevrolet	T143016KX	JM Lado Caja	1996	-	Esteem 1.3/1.6	MT	L/R	NA	22	21	40	57.5	71	NA

Grand Vitara							Generales		Características Técnicas						
Datos del producto															
Marca	# Transejes®	Producto	Año Inicial	Año Final	Modelo		MT/AT	L/R	ABS	A	B	C	H	L	P
Chevrolet	T120211KX	JF Lado Rueda	1998	2003	Grand Vitara I (1,6 4X4 MT/2.0 4X4 MT-AT/2.0 Td 4X4 AT/2.5 V6 24V 4X4 AT)		MT/AT	L/R	NA	26	29	48	116	65.5	I
Chevrolet	T123625KX	JF Lado Rueda	2006	2012	Grand Vitara Jii (Diseño Spicer) Colombia Ecuador		MT	L/R	NA	26	24	48	115.5	68.5	M
Chevrolet	T123626KX	JF Lado Rueda	2009	-	Grand Vitara Sz Grand Vitara Jii 4X4 2.4		MT/AT	L/R	NA	28	26	58	82	73	O
Chevrolet	T144015KX	JM Lado Caja	2009	2014	Grand Vitara Sz Grand Vitara Jii 4X4 2.4		MT	R	NA	NA	26	87	71	NA	NA
Chevrolet	T175027KX	Eje Homocinético	2007	-	Grand Vitara Sz Eje Tras 4X4 2.0 // 2.4 L		MT/AT	L/R	NA	28	NA	58.3	82	600 / 650	NA
Chevrolet	T175049KX	Eje Homocinético	2000	2012	Grand Vitara Jii Colombia - Ecuador		MT	R	NA	26	26	48.0	115	605	NA
Chevrolet	T175050KX	Eje Homocinético	2000	2012	Grand Vitara Jii Colombia - Ecuador		MT	L	NA	26	NA	48.0	115	533	NA

LUV							Generales		Características Técnicas						
Datos del producto															
Marca	# Transejes®	Producto	Año Inicial	Año Final	Modelo		MT/AT	L/R	ABS	A	B	C	H	L	P
Chevrolet	T120205KX	JF Lado Rueda	1993	-	Luv 2.3		MT	L/R	NA	17	23	53	144	62.5	M
Chevrolet	T120209KX	JF Lado Rueda	2002	2014	D-Max 3.0/Rodeo/Luv 2,2.(Vastago Punta Pin Roscado/ D-Max De Lujo)		MT	L/R	NA	17	33	53	144	69.5	I
Chevrolet	T121601KX	JF Lado Rueda	1993	-	Luv 1.6		MT	L/R	NA	24	23	47.9	149	56	M
Chevrolet	T144014KX	JM Lado Caja	1993	-	Luv 2.3 Larga		MT	R	NA	23	23	28	487	90	NA
Chevrolet	T174000KX	Eje Homocinético	1990	1998	Luv 2.3(4Zd1) Pick Up (Largo)		MT	R	NA	17	23	53	144.05	952.5 / 992.5	NA
Chevrolet	T174001KX	Eje Homocinético	1990	1998	Luv 2.3(4Zd1) Pick Up (Corto)		MT	L	NA	17	23	53	144.05	562 / 607	NA
Chevrolet	T174002KX	Eje Homocinético	1990	1998	Luv 1.6 (4Za1) Pick Up (Largo)		MT	L/R	NA	24	23	47.9	149	953.5 / 1007.5	NA

Meriva/Monza							Generales		Características Técnicas						
Datos del producto															
Marca	# Transejes®	Producto	Año Inicial	Año Final	Modelo		MT/AT	L/R	ABS	A	B	C	H	L	P
Chevrolet	T120220KX	JF Lado Rueda	2002	2006	Meriva		MT	L/R	NA	22	23	52	97.5	61	M
Chevrolet	T120203KX	JF Lado Rueda	1989	-	Monza 1.8/2.0		MT	L/R	NA	33	25	52	109	61	O
Chevrolet	T144058KX	JM Lado Caja	1996	-	Monza		MT/AT	L/R	NA	22	28	35	57.5	93	NA

Optra							Generales		Características Técnicas						
Datos del producto															
Marca	# Transejes®	Producto	Año Inicial	Año Final	Modelo		MT/AT	L/R	ABS	A	B	C	H	L	P
Chevrolet	T120206KX	JF Lado Rueda	2004	-	Optra Abs		MT	L/R	47	33	23	52	96	57	M
Chevrolet	T123627KX	JF Lado Rueda	2004	-	Optra 1.8 Abs		MT	L/R	47	33	29	52	92.5	63	O
Chevrolet	T123628KX	JF Lado Rueda	2004	-	Optra Abs		MT	L/R	47	33	22	52	95.5	53	O
Chevrolet	T140208KX	JM Lado Caja	2006	-	Optra 1.8		MT	L/R	NA	34	24	35	56.5	106.5	NA
Chevrolet	T144009KX	JM Lado Caja	2006	-	Optra 1.4 Mecánico		MT/AT	L/R	NA	34	22	35	56.5	69	NA
Chevrolet	T175025KX	Eje Homocinético	2004	-	Optra 1.4 Sin Abs		MT	L	NA	33	34	52	95.5	611	NA
Chevrolet	T175026KX	Eje Homocinético	2004	-	Optra 1.4 Sin Abs		MT	R	NA	33	34	52	95.5	932	NA

Sail							Generales		Características Técnicas						
Datos del producto															
Marca	# Transejes®	Producto	Año Inicial	Año Final	Modelo		MT/AT	L/R	ABS	A	B	C	H	L	P
Chevrolet	T120222KX	JF Lado Rueda	2013	2019	Sail		MT	L/R	47	22	22	52	95	56.5	M
Chevrolet	T140207KX	JM Lado Caja	2012	2019	Sail		MT	L/R	NA	22	22	35	56	97	NA
Chevrolet	T170203KX	Eje Homocinético	2012	-	Sail		MT	L	47	22	22	52	95	605-652	NA
Chevrolet	T170204KX	Eje Homocinético	2012	-	Sail		MT	R	47	22	22	52	95	919-966	NA

Spark							Generales		Características Técnicas						
Datos del producto															
Marca	# Transejes®	Producto	Año Inicial	Año Final	Modelo		MT/AT	L/R	ABS	A	B	C	H	L	P
Chevrolet	T120601KX	JF Lado Rueda	2010	-	Spark (Taxi 7:24/Cronos)		MT	L/R	NA	23	19	46	92	56.5	O
Chevrolet	T123623KX	JF Lado Rueda	2010	-	Spark (Taxi 7:24/Cronos)		MT	L/R	NA	23	21	46	92	60.63	M
Chevrolet	T131854KX	Bota Lado Rueda	2005	-	Spark (Taxi 7:24/Cronos)/Matiz		MT	L/R	NA	NA	NA	NA	NA	NA	NA
Chevrolet	T143013KX	JM Lado Caja	2004	-	Spark (Taxi 7:24/Cronos)		MT	L/R	NA	22	19	35	50.5	78	NA
Chevrolet	T144012KX	JM Lado Caja	2010	-	Spark (Taxi 7:24/Cronos)		MT	L/R	NA	22	21	35	50	59.5	NA
Chevrolet	T150200KX	Bota Lado Caja	2005	2019	Spark 1.0 (M200, M250)		MT	L/R	NA	NA	NA	NA	NA	NA	NA
Chevrolet	T173416KX	Eje Homocinético	2010	-	Spark		MT	R	NA	23	22	44	71.5	832	NA
Chevrolet	T173417KX	Eje Homocinético	2010	-	Spark		MT	L	NA	23	22	44	71.5	563	NA
Chevrolet	T144017KX	JM Lado Caja	2010	-	Spark Gt		MT	L/R	NA	21	20	35	50.5	85	NA
Chevrolet	T144055KX	JM Lado Caja	2011	-	Spark Gt		MT	L/R	NA	22	20	35	50	82	NA
Chevrolet	T175022KX	Eje Homocinético	2010	-	Spark Gt		MT	R	NA	22	22	52	96	563	NA
Chevrolet	T175024KX	Eje Homocinético	2010	-	Spark Gt		MT	L	NA	22	22	52	96	621 / 661	NA

Sprint							Generales		Características Técnicas						
Datos del producto															
Marca	# Transejes®	Producto	Año Inicial	Año Final	Modelo		MT/AT	L/R	ABS	A	B	C	H	L	P
Chevrolet	T123000KX	JF Lado Rueda	1987	-	Sprint - Ntn		MT	L/R	NA	23	19	44	89	54	M
Chevrolet	T123011KX	JF Lado Rueda	1987	-	Sprint		MT	L/R	NA	23	20	44	89	54	O
Chevrolet	T132812KX	Bota Lado Caja	1987	-	Sprint		MT	L/R	NA	NA	NA	NA	NA	NA	NA
Chevrolet	T143000KX	JM Lado Caja	1987	-	Sprint Ntn		MT	L/R	NA	22	19	35	51.5	83	NA
Chevrolet	T143005KX	JM Lado Caja	1987	-	Sprint Spicer		MT	L/R	NA	22	19	35	76	150	NA
Chevrolet	T163000KX	Tripode Lado Caja	1987	-	Sprint/M200CKD/Swift 19 dientes		MT	L/R	NA	19	28	NA	NA	NA	NA
Chevrolet	T175004KX	Eje Homocinético	1987	-	Sprint		MT	L	NA	23	22	44	72	667	NA
Chevrolet	T175005KX	Eje Homocinético	1987	-	Sprint		MT	R	NA	23	22	44	72	760	NA

Swift							Generales		Características Técnicas						
Datos del producto															
Marca	# Transejes®	Producto	Año Inicial	Año Final	Modelo		MT/AT	L/R	ABS	A	B	C	H	L	P
Chevrolet	T123001KX	JF Lado Rueda	2003	-	Swift 1.0		MT	L/R	NA	23	19	49	92	56.5	M
Chevrolet	T123002KX	JF Lado Rueda	1990	-	Swift Sincronico 1.6		MT/AT	L/R	NA	23	22	49	76	73	M
Chevrolet	T123005KX	JF Lado Rueda	1989	2001	Swift 1.6 Sincronico		MT/AT	L/R	NA	25	22	49	76	73	M
Chevrolet	T123007KX	JF Lado Rueda	1990	-	Swift 1.0/1.3		MT	L/R	NA	23	19	44	89.5	54.5	M
Chevrolet	T123010KX	JF Lado Rueda	1990	-	Swift 1.3		MT	L/R	NA	23	20	49	92	46	O
Chevrolet	T131802KX	Bota LC y LR	1990	-	Swift Sincronico Y Automático 1.6		MT/AT	L/R	NA	NA	NA	NA	NA	NA	NA
Chevrolet	T132812KX	Bota Lado Caja	1987	-	Swift		MT	L/R	NA	NA	NA	NA	NA	NA	NA
Chevrolet	T143001KX	JM Lado Caja	1990	-	Swift 1.3 Hembra Tipo Ntn		MT	R	NA	22	19	40	57.5	71	NA
Chevrolet	T143003KX	JM Lado Caja	1990	-	Swift 1.3 Macho Spicer		MT	L	NA	22	22	40	76	138	NA
Chevrolet	T143012KX	JM Lado Caja	1990	-	Swift 1.3 Macho Tipo Ntn		MT	L/R	NA	22	19	35	54.4	86	NA
Chevrolet	T143019KX	JM Lado Caja	1990	-	Swift 1.6		MT	L	NA	26	22	38	76	176	NA
Chevrolet	T173001KX	Eje Homocinético	1990	-	Swift 1.3		MT	R	NA	23	22	49	71.5	586	NA
Chevrolet	T173002KX	Eje Homocinético	1990	-	Swift 1.3		MT	L	NA	23	22	49	71.5	601	NA

Tracker/Trooper							Generales		Características Técnicas							
Datos del producto																
Marca	# Transejes®	Producto	Año Inicial	Año Final	Modelo		MT/AT	L/R	ABS	A	B	C	H	L	P	
<b>Nueva!!</b>	Chevrolet	T120224KX	JF Lado Rueda	2012	2021	Tracker 1,8		MT/AT	L/R	NA	25	23	52.5	92	151.5	M
	Chevrolet	T121602KX	JF Lado Rueda	1989	-	Trooper		MT	L/R	NA	17	26	53	144	70.5	M
	Chevrolet	T131859KX	Bota Lado Rueda	1989	-	Trooper		MT	L/R	NA	NA	NA	NA	NA	NA	

Vitara							Generales		Características Técnicas						
Datos del producto															
Marca	# Transejes®	Producto	Año Inicial	Año Final	Modelo		MT/AT	L/R	ABS	A	B	C	H	L	P
Chevrolet	T123004KX	JF Lado Rueda	1995	2007	Vitara 1.6		MT/AT	L/R	NA	26	22	48	116.5	65.5	M
Chevrolet	T131802KX	Bota LC y LR	1990	-	Vitara 1.6		MT/AT	L/R	NA	NA	NA	NA	NA	NA	NA

## Citroën

Marca	# Transejes®	Producto	Año Inicial	Año Final	Modelo	MT/AT	L/R	ABS	A	B	C	H	L	P
Citroën	T123639KX	JF Lado Rueda	1991	-	Citroën Bx/Cx	MT	L/R	NA	25	22	54.8	79	48	I
Citroën	T123640KX	JF Lado Rueda	1997	-	Citroën Jumper	MT	L/R	NA	35	45	70	117	73	I
Citroën	T123641KX	JF Lado Rueda	1997	-	Citroën Jumper Mn.	MT	L/R	NA	35	29	71.5	127	71	M

## Daewoo

Cielo						Datos del producto			Generales			Características Técnicas				
Marca	# Transejes®	Producto	Año Inicial	Año Final	Modelo	MT/AT	L/R	ABS	A	B	C	H	L	P		
Daewoo	T120602KX	JF Lado Rueda	1993	1997	Cielo 1.5	MT	L/R	NA	22	29	52	96.5	63	O		
Daewoo	T140602KX	JM Lado Caja	1995	-	Cielo	MT	L/R	NA	34	22	35	56.2	76	NA		
Daewoo	T1706001KX	Eje Homocinético	1993	-	Cielo	MT	R	NA	22	34	52	95	906	NA		
Daewoo	T1706002KX	Eje Homocinético	1993	2000	Cielo	MT	L	NA	23	22	44	89.5	667 - 721	NA		

## Espero/Lanos

Espero/Lanos						Datos del producto			Generales			Características Técnicas				
Marca	# Transejes®	Producto	Año Inicial	Año Final	Modelo	MT/AT	L/R	ABS	A	B	C	H	L	P		
Daewoo	T120600KX	JF Lado Rueda	1992	-	Espero 2000	MT	L/R	NA	33	29	52	109	63	O		
Daewoo	T120214KX	JF Lado Rueda	1996	-	Lanos	MT	L/R	NA	22	22	52	96	56	I		
Daewoo	T120602KX	JF Lado Rueda	1997	-	Lanos 1.3 / 1.5	MT	L/R	NA	22	29	52	96.5	63	O		

## Matiz

Matiz						Datos del producto			Generales			Características Técnicas				
Marca	# Transejes®	Producto	Año Inicial	Año Final	Modelo	MT/AT	L/R	ABS	A	B	C	H	L	P		
Daewoo	T120601KX	JF Lado Rueda	2010	-	Matiz	MT	L/R	NA	23	19	46	92	56.5	O		
Daewoo	T131854KX	Bota Lado Rueda	2005	-	ATos / Spark Cronos / Spark 7.24 / Matiz	MT	L/R	NA	NA	NA	NA	NA	NA	NA		
Daewoo	T140205KX	JM Lado Caja	1999	-	Matiz	MT	L/R	NA	22	19	35	54.5	79	NA		

## Racer

Racer						Datos del producto			Generales			Características Técnicas				
Marca	# Transejes®	Producto	Año Inicial	Año Final	Modelo	MT/AT	L/R	ABS	A	B	C	H	L	P		
Daewoo	T120602KX	JF Lado Rueda	1994	1997	Racer 1.3 / 1.5	MT	L/R	NA	22	29	52	96.5	63	O		
Daewoo	T120604KX	JF Lado Rueda	1993	-	Racer 1.6/2.0	MT	L/R	NA	22	29	52	95	62.5	O		
Daewoo	T140602KX	JM Lado Caja	1993	-	Racer	MT	L/R	NA	34	22	35	56.2	76	NA		
Daewoo	T1706001KX	Eje Homocinético	1993	2000	Racer	MT	R	NA	22	34	52	95	906	NA		
Daewoo	T1706002KX	Eje Homocinético	1993	2000	Racer	MT	L	NA	23	22	44	89.5	667 - 721	NA		

## Sonata/Tico

Sonata/Tico						Datos del producto			Generales			Características Técnicas				
Marca	# Transejes®	Producto	Año Inicial	Año Final	Modelo	MT/AT	L/R	ABS	A	B	C	H	L	P		
Daewoo	T121400KX	JF Lado Rueda	1995	-	Sonata 2.0	MT	L/R	NA	25	25	50	95	65	M		
Daewoo	T120603KX	JF Lado Rueda	1996	-	Tico	MT	L/R	NA	23	19	44	92	56.5	O		
Daewoo	T140205KX	JM Lado Caja	2010	-	Tico	MT	L/R	NA	22	19	35	54.5	79	NA		
Daewoo	T1706001KX	Eje Homocinético	1993	2000	Tico	MT	R	NA	22	34	52	95	906	NA		
Daewoo	T1706002KX	Eje Homocinético	1993	2000	Tico	MT	L	NA	23	22	44	89.5	667 - 721	NA		
Daewoo	T170603KX	Eje Homocinético	1993	2001	Tico	MT	R	NA	23	22	44	89.5	756 - 810	NA		

## Daihatsu/Dodge

Daihatsu/Dodge						Datos del producto			Generales			Características Técnicas				
Marca	# Transejes®	Producto	Año Inicial	Año Final	Modelo	MT/AT	L/R	ABS	A	B	C	H	L	P		
Daihatsu	T123207KX	JF Lado Rueda	1998	2006	Terius	MT/AT	L/R	NA	24	19	52	94	81.5	M		
Daihatsu	T144028KX	JM Lado Caja	1980	-	Terius	MT	L	NA	23	19	35	55.5	86	NA		
Dodge	T126001KX	JF Lado Rueda	2011	2015	Dodge Journey 2.4	AT	L/R	NA	32	32	57	104	62	I		

## Fiat

Fiat						Datos del producto			Generales			Características Técnicas				
Marca	# Transejes®	Producto	Año Inicial	Año Final	Modelo	MT/AT	L/R	ABS	A	B	C	H	L	P		
Fiat	T120800KX	JF Lado Rueda	1981	2000	Fiat 147	MT	L/R	NA	20	20	43.1	90.5	60.5	O		
Fiat	T120800KX	JF Lado Rueda	1988	2006	Fiat Uno 1.1/1.4	MT	L/R	NA	20	20	43.1	90.5	60.5	O		
Fiat	T120805KX	JF Lado Rueda	1993	-	Fiat Uno	MT	L/R	NA	22	20	48.1	90.5	59.5	O		
Fiat	T120800KX	JF Lado Rueda	1994	2001	Fiorino Pick Up 1.4	MT	L/R	NA	20	20	43.1	90.5	60.5	O		
Fiat	T120805KX	JF Lado Rueda	1993	-	Fiorino	MT	L/R	NA	22	20	48.1	90.5	59.5	O		
Fiat	T120801KX	JF Lado Rueda	1997	-	Palio 1.3	MT	L/R	NA	22	20	52	91	60.5	O		
Fiat	T120805KX	JF Lado Rueda	1993	-	Premio	MT	L/R	NA	22	20	48.1	90.5	59.5	O		
Fiat	T120803KX	JF Lado Rueda	1993	-	Tempra 1.6	MT	L/R	NA	22	20	46.8	75.5	52	O		
Fiat	T120804KX	JF Lado Rueda	1993	-	Tempra 1.8	MT	L/R	NA	25	25	52	85	58	I		
Fiat	T120805KX	JF Lado Rueda	1993	-	Tucan	MT	L/R	NA	22	20	48.1	90.5	59.5	O		

## Ford

2600/Charger/Charrier						Datos del producto			Generales			Características Técnicas				
Marca	# Transejes®	Producto	Año Inicial	Año Final	Modelo	MT/AT	L/R	ABS	A	B	C	H	L	P		
Ford	T121815KX	JF Lado Rueda	2002	-	Ford 2600	MT	L/R	NA	26	25	65	143.5	60.5	M		
Ford	T144032KX	JM Lado Caja	1998	-	Charger/Fiesta	MT	L	NA	23	21	40	371	78.1	NA		
Ford	T144029KX	JM Lado Caja	1998	-	Charrier	MT	R	NA	23	21	31.5	372	75	NA		

## Eco Sport

Eco Sport						Datos del producto			Generales			Características Técnicas				
Marca	# Transejes®	Producto	Año Inicial	Año Final	Modelo	MT/AT	L/R	ABS	A	B	C	H	L	P		
Ford	T121008KX	JF Lado Rueda	2003	2011	Eco Sport 2.0 4X2	MT	L/R	NA	25	23	53.38	88.5	57	M		
Ford	T123642KX	JF Lado Rueda	2004	2012	Eco Sport 2.0 4X4	MT	L/R	NA	25	24	51	88.5	61.4	M		
Ford	T144031KX	JM Lado Caja	1989	-	Eco Sport 4X2	MT	L	NA	23	23	27.9	61.3	432	NA		
Ford	T144031KX	JM Lado Caja	2004	-	Eco Sport 4X2	MT	R	NA	23	23	52.5	401	91	NA		

## Escape/Explorer

Escape/Explorer						Datos del producto			Generales			Características Técnicas				
Marca	# Transejes®	Producto	Año Inicial	Año Final	Modelo	MT/AT	L/R	ABS	A	B	C	H	L	P		
Ford	T123688KX	JF Lado Rueda	2001	-	Escape	MT	L/R	44	28	24	56	94	62	M		
Ford	T121006KX	JF Lado Rueda	1993	-	Explorer U-207	MT	L/R	NA	27	34	59.7	112	80	I		
Ford	T121001KX	JF Lado Rueda	1993	1995	Ford Fiesta(1.3 Aut)/Mazda 121	MT/AT	L/R	NA	24	19	52	86	50.5	M		

## Festiva

Festiva						Datos del producto			Generales			Características Técnicas				
Marca	# Transejes®	Producto	Año Inicial	Año Final	Modelo	MT/AT	L/R	ABS	A	B	C	H	L	P		
Ford	T121002KX	JF Lado Rueda	1993	-	Festiva	MT	L/R	NA	24	20	52	86	50.5	M		
Ford	T141816KX	JM Lado Caja	1993	-	Festiva	MT	L/R	NA	22	19	35	59	82	NA		
Ford	T141817KX	JM Lado Caja	1993	-	Festiva	MT	L/R	NA	22	20	35	58	82	NA		
Ford	T171805KX	Eje Homocinético	1993	-	Festiva	MT	R	44	24	22	52	71.5	880	NA		

Fiesta														
Datos del producto						Generales			Características Técnicas					
Marca	# Transejes®	Producto	Año Inicial	Año Final	Modelo	MT/AT	L/R	ABS	A	B	C	H	L	P
Ford	T121003KX	JF Lado Rueda	1995	2000	Fiesta (1.25/1.6 MT); Fiesta Escort Classic/Turnier(1.6 AT); Fiesta Furgoneta(1.8 MT)	MT/AT	L/R	NA	25	22	56	87.8	49.5	O
Ford	T144029KX	JM Lado Caja	1998	-	Fiesta	MT	R	NA	23	21	31.5	372	75	NA
Ford	T144032KX	JM Lado Caja	1998	-	Charger/Fiesta	MT	L	NA	23	21	40	371	78.1	NA
Ford	T144032KX	JM Lado Caja	1998	-	Fiesta	MT	L	NA	23	21	40	371	78.1	NA

Focus/Fortaleza														
Datos del producto						Generales			Características Técnicas					
Marca	# Transejes®	Producto	Año Inicial	Año Final	Modelo	MT/AT	L/R	ABS	A	B	C	H	L	P
Ford	T121008KX	JF Lado Rueda	2000	2008	Focus/Hatch(2.0/1.8 MT-AT)	MT	L/R	NA	25	23	53.38	88.5	57	M
Ford	T144032KX	JM Lado Caja	1998	2004	Ford Focus Mk1 (Hatchback/Estate/Saloon)	MT	L	NA	23	21	40	371	78.1	NA
Ford	T123643KX	JF Lado Rueda	1997	2002	Ford Fortaleza/150 Expedition	MT	L/R	NA	33	28	75.6	113.2	76	I
Ford	T123643KX	JF Lado Rueda	1997	-	Fortaleza	MT	L/R	44	33	28	75.6	113.2	76	I

Ranger														
Datos del producto						Generales			Características Técnicas					
Marca	# Transejes®	Producto	Año Inicial	Año Final	Modelo	MT/AT	L/R	ABS	A	B	C	H	L	P
Ford	T121006KX	JF Lado Rueda	1993	-	Ranger Venezuela	MT	L/R	NA	27	34	59.7	112	80	I
Ford	T144049KX	JM Lado Caja	2006	2012	Ranger 2.5 / 3.0 Tdci 4X4 Macho	MT/AT	R	NA	30	36	38	94.5	101	NA
Ford	T144050KX	JM Lado Caja	2006	2012	Ranger 2.5 / 3.0 Tdci 4X4 Hembra	MT	L	NA	28	36	42	35.5	112	NA
Ford	T144051KX	JM Lado Caja	2002	-	Ranger 2.5 Gasolina Macho	MT	R	44	26	25	35	82.5	95.5	NA
Ford	T144053KX	JM Lado Caja	1999	2006	Ranger 2.5 Gasolina 4X4 Hembra	MT	L	NA	26	25	40	25.5	68	NA
Ford	T144054KX	JM Lado Caja	1999	2006	Ranger 2.5 Hembra	MT	L	NA	26	25	40	25.5	81	NA

Geely														
Datos del producto						Generales			Características Técnicas					
Marca	# Transejes®	Producto	Año Inicial	Año Final	Modelo	MT/AT	L/R	ABS	A	B	C	H	L	P
Geely	T123644KX	JF Lado Rueda	2012	-	Geely 1.3	MT	L/R	NA	24	21	54.5	92	52	I

Honda														
Datos del producto						Generales			Características Técnicas					
Marca	# Transejes®	Producto	Año Inicial	Año Final	Modelo	MT/AT	L/R	ABS	A	B	C	H	L	P
Honda	T131802KX	Bota LC y LR	1990	-	Accord	MT/AT	L/R	NA	NA	NA	NA	NA	NA	NA
Honda	T123674KX	JF Lado Rueda	1998	-	Accord VII	MT	L/R	50	28	32	64	88.5	60.5	I
Honda	T144069KX	JM Lado Caja	2003	2015	Accord VII/VIII 2.4 Hembra	MT	R	NA	27	32	40	36	84.5	NA
Honda	T144070KX	JM Lado Caja	2003	2015	Accord VII/VIII 2.4 Macho	MT	L	NA	27	32	40	58.5	97	NA
Honda	T121201KX	JF Lado Rueda	1993	-	Civic 1.5 MTX / ATx	MT/AT	L/R	NA	23	30	49	79.5	56	M
Honda	T144069KX	JM Lado Caja	2006	-	CRV V/CRV V III 2.4 (4X2/4X4) Hembra	MT/AT	R	NA	27	32	40	36	84.5	NA
Honda	T144070KX	JM Lado Caja	2006	-	CRV V/CRV V III 2.4 (4X2/4X4) Macho	MT/AT	L	NA	27	32	40	58.5	97	NA
Honda	T144063KX	JM Lado Caja	1991	-	Legend	MT	L/R	NA	31	36	42	64.1	106	NA

### Hyundai

Accent														
Datos del producto						Generales			Características Técnicas					
Marca	# Transejes®	Producto	Año Inicial	Año Final	Modelo	MT/AT	L/R	ABS	A	B	C	H	L	P
Hyundai	T121404KX	JF Lado Rueda	2000	-	Accent-Verna-Vision	MT	L/R	NA	25	22	50	97	57	M
Hyundai	T121405KX	JF Lado Rueda	1995	-	Accent (Verna/Gyro/Vision) (Pin Ext.)	MT	L/R	NA	25	30	49.9	94.5	56	O
Hyundai	T121406KX	JF Lado Rueda	2000	2005	Accent III (Lc)	AT	L/R	NA	25	22	52.5	95	58	M
Hyundai	T123697KX	JF Lado Rueda	2005	2010	Accent III 1.4 / 1.6 Gls / Gl	MT/AT	L/R	48	25	22	52.5	95	58	M
Hyundai	T141404KX	JM Lado Caja	2000	-	Accent	MT	L/R	NA	25	22	35	80	145.5	NA
Hyundai	T141405KX	JM Lado Caja	2005	2010	Accent Ili (Mc)	MT	R	NA	25	22	35	63	87	NA
Hyundai	T141406KX	JM Lado Caja	1995	1999	Accent	MT	L	NA	25	22	35	55	91	NA
Hyundai	T151400KX	Bota Lado Caja	1994	-	Accent (Vision, Verna, Gyro)	MT	L/R	NA	NA	NA	NA	NA	NA	NA
Hyundai	T171401KX	Eje Homocinético	1995	2004	Accent 1.5	MT	L	NA	25	25	50	79.5	596.5	NA
Hyundai	T171402KX	Eje Homocinético	1995	2004	Accent 1.5	MT	R	NA	25	25	50	79.5	909	NA

Atos														
Datos del producto						Generales			Características Técnicas					
Marca	# Transejes®	Producto	Año Inicial	Año Final	Modelo	MT/AT	L/R	ABS	A	B	C	H	L	P
Hyundai	T121401KX	JF Lado Rueda	1998	2003	Atos	MT	L/R	NA	25	19	50	94.5	52.5	M
Hyundai	T121403KX	JF Lado Rueda	2003	2014	Atos	MT	L/R	NA	25	20	50	94.5	52.5	I
Hyundai	T131854KX	Bota Lado Rueda	2005	-	Atos / Spark Cronos / Spark 7:24 / Matiz	MT	L/R	NA	NA	NA	NA	NA	NA	NA
Hyundai	T132812KX	Bota Lado Caja	1987	-	Atos	MT	L/R	NA	NA	NA	NA	NA	NA	NA
Hyundai	T141401KX	JM Lado Caja	1998	2008	Atos Tipo Thc	MT	L/R	NA	22	20	35	52	86	NA
Hyundai	T141402KX	JM Lado Caja	2005	-	Atos Hindu T-Ntn	MT	L/R	NA	22	20	35	52	86	NA
Hyundai	T141403KX	JM Lado Caja	1998	2003	Atos T. Korea	MT	L/R	NA	22	19	35	51.5	86.5	NA
Hyundai	T173420KX	Eje Homocinético	1998	-	Atos	MT	R	NA	25	22	50	71.5	810	NA
Hyundai	T173421KX	Eje Homocinético	1998	-	Atos	MT	L	NA	25	22	50	71.5	596	NA

Elantra/Excell														
Datos del producto						Generales			Características Técnicas					
Marca	# Transejes®	Producto	Año Inicial	Año Final	Modelo	MT/AT	L/R	ABS	A	B	C	H	L	P
Hyundai	T121407KX	JF Lado Rueda	1990	1995	Elantra I (J-1)	MT	L/R	NA	25	30	50	95	56.5	M
Hyundai	T123694KX	JF Lado Rueda	2000	-	Elantra 1.6	MT	L/R	44	27	23	60	95	60	M
Hyundai	T123696KX	JF Lado Rueda	2000	2010	Elantra III (XD) 1.6 / 2.0	MT	L/R	44	25	30	50	95.5	60.5	M
Hyundai	T144073KX	JM Lado Caja	2011	-	Elantra 11 1.6	AT	R	NA	25	22	41	63	86	NA
Hyundai	T121402KX	JF Lado Rueda	1993	-	Excell Ls Scoupe	MT	L/R	NA	25	22	50	95	58	M
Hyundai	T131802KX	Bota LC y LR	2002	-	Excell Coupe	MT/AT	L/R	NA	NA	NA	NA	NA	NA	NA

Getz/Giro														
Datos del producto						Generales			Características Técnicas					
Marca	# Transejes®	Producto	Año Inicial	Año Final	Modelo	MT/AT	L/R	ABS	A	B	C	H	L	P
Hyundai	T123697KX	JF Lado Rueda	2003	2010	Getz (Tb) 1.3i / 1.4i / 1.6i	MT	L/R	48	25	22	52.5	95	58	M
Hyundai	T144077KX	JM Lado Caja	2006	-	Getz (Tb) 1.4	AT	L	NA	25	22	35	63	87	NA
Hyundai	T141404KX	JM Lado Caja	2000	-	Giro	MT	L/R	NA	25	22	35	80	145.5	NA

I-10														
Datos del producto						Generales			Características Técnicas					
Marca	# Transejes®	Producto	Año Inicial	Año Final	Modelo	MT/AT	L/R	ABS	A	B	C	H	L	P
Hyundai	T123606KX	JF Lado Rueda	2009	-	I-10	MT	L/R	NA	24	20	52.5	86.5	63	M
Hyundai	T144003KX	JM Lado Caja	2009	-	I-10	AT	R	NA	25	20	35	54	91	NA
Hyundai	T175028KX	Eje Homocinético	2009	-	I-10 Rh	MT	R	NA	24	25	52.5	86.5	84.5	NA
Hyundai	T175031KX	Eje Homocinético	2009	-	I-10 Lh	MT	L	NA	24	25	52.5	86.5	62.4	NA

Matrix/Santa Fe														
Datos del producto						Generales			Características Técnicas					
Marca	# Transejes®	Producto	Año Inicial	Año Final	Modelo	MT/AT	L/R	ABS	A	B	C	H	L	P
Hyundai	T123696KX	JF Lado Rueda	2001	2010	Matrix 1.8	MT	L/R	44	25	30	50	95.5	60.5	M
Hyundai	T144074KX	JM Lado Caja	2001	2010	Matrix 1.8	MT	-	NA	27	25	41	62.5	93	NA
Hyundai	T123629KX	JF Lado Rueda	2001	2006	Santa Fe (2.0/2.7 V6 4X4)	MT	L/R	52	27	26	60	95	69	M
Hyundai	T123630KX	JF Lado Rueda	2001	2010	Santa Fe II 2.2/2.4 (4X2 y 4X4)	MT/AT	L/R	52	30	36	73	96	67.5	I
Hyundai	T123630KX	JF Lado Rueda	2006	2009	Santa Fe II 2.7 (4X2 y 4X4)	MT/AT	L/R	52	30	36	73	96	67.5	I
Hyundai	T123630KX	JF Lado Rueda	2006	2009	Santa Fe II 3.5 Limited	AT	L/R	52	30	36	73	96	67.5	I
Hyundai	T123670KX	JF Lado Rueda	2006	-	Santa Fe 2.7 4X4 AT	AT	R	NA	30	36	73	97	67.5	I
Hyundai	T123698KX	JF Lado Rueda	2001	-	Santa Fe I 2.4	MT	L/R	47	27	25	-	95	63.5	M



Tucson														
Datos del producto						Generales		Características Técnicas						
Marca	# Transejes®	Producto	Año Inicial	Año Final	Modelo	MT/AT	L/R	ABS	A	B	C	H	L	P
Hyundai	T120217KX	JF Lado Rueda	2008	-	Tucson 4X2	MT	L/R	48	27	23	62	94	60	M
Hyundai	T123607KX	JF Lado Rueda	2005	-	Tucson 4X2 Autmática	AT	L/R	NA	29	33	68	156	73.8	O
Hyundai	T123631KX	JF Lado Rueda	2004	2010	Tucson Abs (2.0 4X2 Y 4X4/2.0 Crdi 4X2 Y 4X4 2.7 Crdi 4X4)	MT	L/R	48	27	25	61.9	95	61	M
Hyundai	T123635KX	JF Lado Rueda	2012	-	Tucson Ix-35 4X4/4X2 Gas MT	MT	L/R	48	27	24	62	95	58	M
Hyundai	T123705KX	JF Lado Rueda	2004	2010	Tucson 2.0 (4X2/4X2)/ Tucson 2.7 4X4 Automatica	MT	L/R	48	27	25	62.2	95	60	M
Hyundai	T144018KX	JM Lado Caja	2005	-	Tucson AT Hd	MT	L/R	NA	27	23	41	63	70	NA
Hyundai	T144019KX	JM Lado Caja	2005	-	Tucson MT Hd 2.0	MT	L/R	NA	27	25	41	62.8	92.5	NA
Hyundai	T175029KX	Eje Homocinético	2005	-	Tucson 4X2 AT Hd	MT	L	48	27	27	62.2	95	668	NA
Hyundai	T175030KX	Eje Homocinético	2005	-	Tucson 4X2 AT Hd	MT	R	48	27	27	62.2	95	955	NA

Veracruz/Verna														
Datos del producto						Generales		Características Técnicas						
Marca	# Transejes®	Producto	Año Inicial	Año Final	Modelo	MT/AT	L/R	ABS	A	B	C	H	L	P
Hyundai	T123670KX	JF Lado Rueda	2006	-	Veracruz	AT	R	NA	30	36	73	97	67.5	I
Hyundai	T123630KX	JF Lado Rueda	2006	2011	Veracruz 3.0/3.8 CRDI 4WD	AT	L/R	52	30	36	73	96	67.5	I
Hyundai	T121404KX	JF Lado Rueda	2000	-	Verna	MT	L/R	NA	25	22	50	97	57	M
Hyundai	T141404KX	JM Lado Caja	2000	-	Verna	MT	L/R	NA	25	22	35	80	145.5	NA
Hyundai	T171403KX	Eje Homocinético	2000	2009	Verna	MT	R	NA	25	25	50	79.5	908	NA
Hyundai	T171404KX	Eje Homocinético	2000	2009	Verna	MT	L	NA	25	25	50	79.5	600	NA

JAC/JEEP														
Datos del producto						Generales		Características Técnicas						
Marca	# Transejes®	Producto	Año Inicial	Año Final	Modelo	MT/AT	L/R	ABS	A	B	C	H	L	P
Jac	T123646KX	JF Lado Rueda	2010	-	Jac 1.3 Taxi	MT	L/R	44	25	29	52.7	95	53	I
Jeep	T120400KX	JF Lado Rueda	1986	1990	Cherokee (Xj) 2.5 4X4	MT	L/R	54	27	32	60	102.5	77.5	I
Jeep	T120401KX	JF Lado Rueda	1986	1990	Cherokee (Xj) 2.5 4X4	MT	L/R	NA	27	32	60	102.5	77.5	I
Jeep	T120400KX	JF Lado Rueda	1993	1999	Grand Cherokee I(5.2 4X4/5.2 Limited 4X4/5.9 I 4X4)	MT	L/R	54	27	32	60	102.5	77.5	I
Jeep	T120401KX	JF Lado Rueda	1993	2000	Grand Cherokee I(5.2 4X4/5.2 Limited 4X4/5.9 I 4X4)	MT	L/R	NA	27	32	60	102.5	77.5	I
Jeep	T123645KX	JF Lado Rueda	1993	-	Grand Cherokee	MT	L/R	NA	36	27	59.5	40	66	I
Jeep	T123645KX	JF Lado Rueda	1993	-	Wagon Abs	MT	L/R	NA	36	27	59.5	40	66	I

### KIA

Carens/Carnival/Grand Carnival														
Datos del producto						Generales		Características Técnicas						
Marca	# Transejes®	Producto	Año Inicial	Año Final	Modelo	MT/AT	L/R	ABS	A	B	C	H	L	P
Kia	T121817KX	JF Lado Rueda	2002	-	Carens Ii Monospace (1.8 / 2.0) Carens Iii Monospace (Un) (2.0)	MT	L/R	46	28	24	56	90	60	M
Kia	T123632KX	JF Lado Rueda	2002	2015	Carens 2.0 Crdi	MT	L/R	NA	28	24	56	90	60	M
Kia	T123633KX	JF Lado Rueda	2006	-	Carnival	MT	R	NA	28	26	56	102	65.7	M
Kia	T144046KX	JM Lado Caja	2001	-	Carnival Gasolina	MT	R	NA	27	24	42	64.7	105	NA
Kia	T123634KX	JF Lado Rueda	2009	-	Grand Carnival	MT	L/R	54	31	28	56	102	69.5	M
Kia	T144020KX	JM Lado Caja	2009	-	Grand Carnival Hembra	MT	R	NA	28	26	42	27	73	NA
Kia	T144022KX	JM Lado Caja	2009	-	Grand Carnival	MT	L	NA	28	26	41	71	73	NA
Kia	T175032KX	Eje Homocinético	2009	-	Grand Carnival	MT	R	54	31	28	56	102	554	NA
Kia	T175035KX	Eje Homocinético	2009	-	Grand Carnival	MT	L	54	31	28	85.5	102	663 / 705.5	NA

I30-Picanto														
Datos del producto						Generales		Características Técnicas						
Marca	# Transejes®	Producto	Año Inicial	Año Final	Modelo	MT/AT	L/R	ABS	A	B	C	H	L	P
Kia	T144026KX	JM Lado Caja	2008	2012	I30 (Fd) 1.4 / 1.6	MT	L/R	NA	25	22	41	62	93.5	NA
Kia	T121002KX	JF Lado Rueda	1993	-	Picanto	MT	L/R	NA	24	20	52	86	50.5	M
Kia	T123608KX	JF Lado Rueda	2009	-	Picanto Ion	MT	L/R	NA	24	20	52.5	86.5	52	M
Kia	T143601KX	JM Lado Caja	2006	-	Picanto	MT	L/R	NA	25	20	35	54.5	82.5	NA
Kia	T173424KX	Eje Homocinético	2009	-	Picanto Ion	MT	R	NA	24	25	52.5	86.5	876 / 916	NA
Kia	T173425KX	Eje Homocinético	2009	-	Picanto Ion	MT	L	NA	24	25	52.5	86.5	606 / 646	NA
Kia	T175033KX	Eje Homocinético	2006	-	Picanto	MT	R	NA	24	25	52	86	850 / 890	NA
Kia	T175036KX	Eje Homocinético	2006	-	Picanto	MT	L	NA	24	25	52	86	634 / 674	NA

Pride														
Datos del producto						Generales		Características Técnicas						
Marca	# Transejes®	Producto	Año Inicial	Año Final	Modelo	MT/AT	L/R	ABS	A	B	C	H	L	P
Kia	T121001KX	JF Lado Rueda	1993	-	Pride	MT/AT	L/R	NA	24	19	52	86	50.5	M
Kia	T141816KX	JM Lado Caja	1993	-	Pride	MT	L/R	NA	22	19	35	59	82	NA
Kia	T141817KX	JM Lado Caja	1993	-	Pride	MT	L/R	NA	22	20	35	58	82	NA
Kia	T171805KX	Eje Homocinético	1993	-	Pride	MT	R	44	24	22	52	71.5	880	NA

Revolution/Rio														
Datos del producto						Generales		Características Técnicas						
Marca	# Transejes®	Producto	Año Inicial	Año Final	Modelo	MT/AT	L/R	ABS	A	B	C	H	L	P
Kia	T144024KX	JM Lado Caja	2012	-	Revolution Gasolina	MT	L/R	NA	27	24	41	61.5	100	NA
Kia	T121812KX	JF Lado Rueda	1984	-	Rio	MT	L/R	NA	24	21	52	86.5	53	M
Kia	T123697KX	JF Lado Rueda	2003	2010	Rio Ii Xcite Sedán (Jb) 1.4 / 1.6 16V	MT/AT	L/R	48	25	22	52.5	95	58	M
Kia	T143600KX	JM Lado Caja	2002	-	Rio 1.3 21T	MT	L/R	NA	26	21	35	76	161	NA
Kia	T144006KX	JM Lado Caja	2001	2004	Rio 1.5	MT	L/R	NA	26	22	35	66.7	92	NA
Kia	T144025KX	JM Lado Caja	2002	-	Rio 1.3 21T	MT	L	NA	26	21	35	66.7	92	NA
Kia	T144026KX	JM Lado Caja	2005	2011	Rio Xcite / Rio Ii (Jb) 1.4 / 1.6 16V	MT	L/R	NA	25	22	41	62	93.5	NA
Kia	T173426KX	Eje Homocinético	2003	-	Rio Xcite	MT	R	48	25	25	52.5	93.5	925	NA
Kia	T173427KX	Eje Homocinético	2005	2011	Rio Xcite // Rio Ii (Jb) 1.4 / 1.6 16V	MT	L	48	25	25	52.5	93.5	637	NA
Kia	T173428KX	Eje Homocinético	2000	2005	Rio Stilus 1.3/1.5	MT	L	NA	24	26	52	86	606 / 636	NA
Kia	T173429KX	Eje Homocinético	2000	2005	Rio Stilus 1.3/1.5	MT	R	NA	24	26	52	86	888 / 918	NA

Sephia														
Datos del producto						Generales		Características Técnicas						
Marca	# Transejes®	Producto	Año Inicial	Año Final	Modelo	MT/AT	L/R	ABS	A	B	C	H	L	P
Kia	T123600KX	JF Lado Rueda	1997	1999	Sephia	MT	L/R	NA	26	23	56	93	56.5	M
Kia	T173426KX	Eje Homocinético	2003	-	Sephia Hd	MT	R	48	25	25	52.5	93.5	925	NA
Kia	T173427KX	Eje Homocinético	2003	-	Sephia Hd	MT	L	48	25	25	52.5	93.5	637	NA

Sorento/Spectra														
Datos del producto						Generales		Características Técnicas						
Marca	# Transejes®	Producto	Año Inicial	Año Final	Modelo	MT/AT	L/R	ABS	A	B	C	H	L	P
Kia	T123630KX	JF Lado Rueda	2009	2015	Sorento II 2.4 (4X2/4WD)/ 2.2 (4X2)	MT/AT	L/R	52	30	36	73	96	67.5	I
Kia	T123636KX	JF Lado Rueda	2012	-	Sorento	MT	L/R	NA	28	25	56	102	63	M
Kia	T144021KX	JM Lado Caja	2012	-	Sorento Hembra	My	R	NA	28	25	43	25	94	NA
Kia	T144023KX	JM Lado Caja	2012	-	Sorento Macho	MT	L	NA	30	25	38	77.5	108	NA
Kia	T175034KX	Eje Homocinético	2012	-	Sorento	MT	R	NA	28	28	56	102	635	NA
Kia	T175037KX	Eje Homocinético	2012	-	Sorento	MT	L	NA	28	28	56	102	567	NA
Kia	T144046KX	JM Lado Caja	2001	-	Spectra Macho	MT	R	NA	27	24	42	64.7	105	NA

Sportage														
Datos del producto						Generales		Características Técnicas						
Marca	# Transejes®	Producto	Año Inicial	Año Final	Modelo	MT/AT	L/R	ABS	A	B	C	H	L	P
Kia	T121815KX	JF Lado Rueda	2002	-	Sportage	MT	L/R	NA	26	25	65	143.5	60.5	M
Kia	T123631KX	JF Lado Rueda	2004	2010	Sportage 2.0/Sportage II 2.0 4wd MT/AT	MT	L/R	48	27	25	61.9	95	61	M
Kia	T123635KX	JF Lado Rueda	2012	-	Sportage 2.0 III/Revolution Hd. 4X2 Y 4X4 6MT 6AT	MT	L/R	48	27	24	62	95	58	M
Kia	T123704KX	JF Lado Rueda	1994	-	Sportage 2.0	MT	L/R	NA	26	24	65	122	62	M
Kia	T123705KX	JF Lado Rueda	2004	-	Sportage 2.0 4X2/4X4	MT	L/R	48	27	25	62.2	95	60	M
Kia	T144046KX	JM Lado Caja	2001	-	Sportage	MT	R	NA	27	24	42	64.7	105	NA
Kia	T175038KX	Eje Homocinético	2012	-	Sportage Revolution Gasolina	MT	R	48	27	27	62	95	967 / 1017	NA

Vision		Datos del producto				Generales			Características Técnicas					
Marca	# Transejes®	Producto	Año Inicial	Año Final	Modelo	MT/AT	L/R	ABS	A	B	C	H	L	P
Kia	T173426KX	Eje Homocinético	2003	-	Vision	MT	R	48	25	25	52.5	93.5	925	NA
Kia	T173427KX	Eje Homocinético	2003	-	Vision	MT	L	48	25	25	52.5	93.5	637	NA

### Mazda

#### Mazda 3

Mazda 3		Datos del producto				Generales			Características Técnicas					
Marca	# Transejes®	Producto	Año Inicial	Año Final	Modelo	MT/AT	L/R	ABS	A	B	C	H	L	P
Mazda	T121818KX	JF Lado Rueda	2005	-	Mazda 3 1.5 Con Tornillo	MT	L/R	NA	36	22	55.2	48.5	55.5	I
Mazda	T123620KX	JF Lado Rueda	2005	2012	Mazda 3	MT/AT	L/R	44	28	22	56	90	59	I
Mazda	T123621KX	JF Lado Rueda	2003	2009	Mazda 3 (2.0/2.3 Mps Turbo/ Sedán 2.0) / Mazda 5(Cr19) 1.8	MT	L/R	NA	28	24	59	90	64	I
Mazda	T144008KX	JM Lado Caja	2005	-	Mazda 3	MT	R	NA	26	23	51.5	66.5	77	NA
Mazda	T175013KX	Eje Homocinético	2005	-	Mazda 3	MT	L	NA	36	26	80.5	48.5	574 / 630	NA
Mazda	T175015KX	Eje Homocinético	2005	-	Mazda 3 Triptónico	MT	L	NA	28	26	59	90	620 / 676	NA

#### Mazda 6

Mazda 6		Datos del producto				Generales			Características Técnicas					
Marca	# Transejes®	Producto	Año Inicial	Año Final	Modelo	MT/AT	L/R	ABS	A	B	C	H	L	P
Mazda	T121816KX	JF Lado Rueda	1986	-	Mazda 6 ATx	MT	L/R	44	28	32	62	90	58	I
Mazda	T121829KX	JF Lado Rueda	2013	-	Mazda 6 (Break 2.5 6AT/Sedan 2.5 6AT)	AT	L/R	NA	31	24	59.5	86.5	69	I
Mazda	T144047KX	JM Lado Caja	2002	2007	Mazda 6 (Macho/Hatchback 2.0 Y 2.3/ Sedan 2.0 Y 2.3)	MT	R	NA	28	33	35	66.5	114	NA
Mazda	T144048KX	JM Lado Caja	2002	2007	Mazda 6 (Hembra/Hatchback 2.0 Y 2.3/ Sedan 2.0 Y 2.3)	MT	L	NA	28	33	43	82	125	NA

#### Mazda121/ Mzada 323

Mazda121/ Mzada 323		Datos del producto				Generales			Características Técnicas					
Marca	# Transejes®	Producto	Año Inicial	Año Final	Modelo	MT/AT	L/R	ABS	A	B	C	H	L	P
Mazda	T171804KX	Eje Homocinético	2002	-	121	MT		NA	24	22	52	86	615 / 631	NA
Mazda	T171805KX	Eje Homocinético	1993	-	121	MT	R	NA	24	22	52	71.5	880	NA
Mazda	T121800KX	JF Lado Rueda	1984	-	323 Japones Original	MT	L/R	NA	24	22	52	86.5	55	M
Mazda	T121801KX	JF Lado Rueda	1991	-	323 1.5	MT	L/R	NA	26	22	56	94	59	I
Mazda	T121808KX	JF Lado Rueda	1984	-	323 Diseño SPICER	MT	L/R	NA	24	30	52	86.5	55	O
Mazda	T121812KX	JF Lado Rueda	1984	-	323 Ecuador	MT	L/R	NA	24	21	52	86.5	53	M
Mazda	T121813KX	JF Lado Rueda	1991	-	323 Vastago largo tipo Allegro	MT/AT	L/R	NA	26	21	56	94	56	M
Mazda	T131802KX	Bota LC y LR	1990	-	323 1.5	MT/AT	L/R	NA	NA	NA	NA	NA	NA	NA
Mazda	T132808KX	Bota Lado Caja	1983	-	323	MT	L/R	NA	NA	NA	NA	NA	NA	NA
Mazda	T141800KX	JM Lado Caja	1984	-	323	MT	L/R	NA	24	22	35	64	87	NA
Mazda	T141812KX	JM Lado Caja	1984	-	323 Ecuador	MT	L/R	NA	24	21	35	64	87	NA
Mazda	T171801KX	Eje Homocinético	1984	-	323	MT	R	NA	24	24	52	79	890	NA
Mazda	T171802KX	Eje Homocinético	1984	-	323	MT	L	NA	24	24	52	79	611	NA
Mazda	T175014KX	Eje Homocinético	1984	-	323	MT	L	NA	28	28	59	90	639	NA

#### Mazda 626

Mazda 626		Datos del producto				Generales			Características Técnicas					
Marca	# Transejes®	Producto	Año Inicial	Año Final	Modelo	MT/AT	L/R	ABS	A	B	C	H	L	P
Mazda	T121802KX	JF Lado Rueda	1991	1997	M626 Matsuri (1.8 / 2.0 / 2.0 Glx)	MT	L/R	NA	28	23	56	90	59	I
Mazda	T121803KX	JF Lado Rueda	1987	1992	M626 (1.8 Engine Gd6P/Gd8S)	MT	L/R	NA	26	23	56	93.5	56.5	M
Mazda	T121804KX	JF Lado Rueda	1988	1994	M626 Asahi 2.0	MT	L/R	NA	26	25	56	93	61	M
Mazda	T121807KX	JF Lado Rueda	1984	1988	M626 1.8	MT	L/R	NA	26	23	52	93	61	M
Mazda	T121809KX	JF Lado Rueda	1984	1988	626 2.0	MT	L/R	NA	26	25	52	92	61	O
Mazda	T121810KX	JF Lado Rueda	1991	1997	M626 Milenium/ Mazda 3	MT	L/R	NA	28	23	56	89	60.5	M
Mazda	T121811KX	JF Lado Rueda	1984	1988	626 1.8	MT	L/R	NA	26	25	52	93	61	O
Mazda	T121820KX	JF Lado Rueda	1999	-	626 2.0 Milenium	MT	L/R	NA	28	30	56	89	59.5	I
Mazda	T123620KX	JF Lado Rueda	1998	2002	626 V Station Wagon (Gw8W) 1.8	MT/AT	L/R	44	28	22	56	90	59	I
Mazda	T131843KX	Bota Lado Rueda	1983	-	626 2.0	MT	L/R	NA	NA	NA	NA	NA	NA	NA
Mazda	T132810KX	Bota Lado Caja	1988	-	626 2.0	MT	L/R	NA	NA	NA	NA	NA	NA	NA
Mazda	T141803KX	JM Lado Caja	1984	-	626 1.8 Hembra	MT	R	NA	26	23	43	37.8	75.5	NA
Mazda	T141807KX	JM Lado Caja	1984	-	626 1.8 Macho	MT	L	NA	26	23	35	66.7	99.5	NA
Mazda	T141811KX	JM Lado Caja	1985	-	626 2.0 Macho	MT	L	NA	26	25	35	66.5	103.4	NA
Mazda	T141813KX	JM Lado Caja	1991	-	626 Matsuri 1.8/2.0 Hembra	MT	R	NA	28	23	42.80	42	76.5	NA
Mazda	T141814KX	JM Lado Caja	1991	-	626 Matsuri 1.8 /2.0 Macho	MT	L	NA	28	23	35	65.5	104	NA

#### Allegro

Allegro		Datos del producto				Generales			Características Técnicas					
Marca	# Transejes®	Producto	Año Inicial	Año Final	Modelo	MT/AT	L/R	ABS	A	B	C	H	L	P
Mazda	T121801KX	JF Lado Rueda	1991	-	Allegro 1.6	MT	L/R	NA	26	22	56	94	59	I
Mazda	T121805KX	JF Lado Rueda	1991	-	Allegro 1.6	MT	L/R	NA	26	28	56	93.5	53	I
Mazda	T121806KX	JF Lado Rueda	1995	1999	Allegro	AT	L/R	NA	26	30	56	93	55	M
Mazda	T121813KX	JF Lado Rueda	1991	-	Allegro 1.6	MT/AT	L/R	NA	26	21	56	94	56	M
Mazda	T121814KX	JF Lado Rueda	1995	-	Allegro 1.6	MT	L/R	NA	26	22	56	94	59	M
Mazda	T121825KX	JF Lado Rueda	1995	-	Allegro 1.8	MT	L/R	NA	26	30	56	93.5	60	I
Mazda	T131802KX	Bota LC y LR	1990	-	Allegro	MT/AT	L/R	NA	NA	NA	NA	NA	NA	NA
Mazda	T131805KX	Bota Lado Rueda	1995	-	Allegro ATm	MT	L/R	NA	NA	NA	NA	NA	NA	NA
Mazda	T132808KX	Bota Lado Caja	1983	-	Allegro	MT	L/R	NA	NA	NA	NA	NA	NA	NA

#### B/B2600

B/B2600		Datos del producto				Generales			Características Técnicas					
Marca	# Transejes®	Producto	Año Inicial	Año Final	Modelo	MT/AT	L/R	ABS	A	B	C	H	L	P
Mazda	T151800KX	Bota Lado Caja	1996	2006	B-Serie 2.5 (Uf, Un) MT	MT	L/R	NA	NA	NA	NA	NA	NA	NA
Mazda	T121815KX	JF Lado Rueda	1997	2004	B2600	MT	L/R	NA	26	25	65	143.5	60.5	M
Mazda	T121819KX	JF Lado Rueda	2005	2012	B2600 Mb - Mn Gasolina (Rosca Vastago)	MT	L/R	NA	26	25	61	103.5	75.5	M
Mazda	T141804KX	JM Lado Caja	2005	2012	B2600 Mn	MT	L	NA	26	25	42.3	37.8	76.5	NA
Mazda	T141818KX	JM Lado Caja	2008	-	B2600 Gasolina (Macho)	MT	R	NA	26	25	35	82.5	108.5	NA
Mazda	T141819KX	JM Lado Caja	1999	-	B2600 Gasolina (Hembra)	MT	L	NA	26	25	40	39	81	NA
Mazda	T144005KX	JM Lado Caja	2008	-	B2600 Hembra 25T	MT	R	NA	25	26	40	33.3	83	NA
Mazda	T171803KX	Eje Homocinético	1997	2004	B2600 Mn Gasolina	MT	L/R	NA	26	26	65	143.5	606	NA
Mazda	T174004KX	Eje Homocinético	2005	2012	B2600 Gasolina (Hembra)	MT	L	NA	26	26	61	103.5	505 / 559	NA
Mazda	T174005KX	Eje Homocinético	2005	2012	B2600 Gasolina (Macho)	MT	R	NA	26	26	61	103.5	578 / 630	NA

#### BT-50 Pick Up Diesel

BT-50 Pick Up Diesel		Datos del producto				Generales			Características Técnicas					
Marca	# Transejes®	Producto	Año Inicial	Año Final	Modelo	MT/AT	L/R	ABS	A	B	C	H	L	P
Mazda	T120215KX	JF Lado Rueda	2008	-	Bt 50 Diesel Abs	MT	L/R	44W	28	36	61	104.5	78.5	I
Mazda	T143023KX	JM Lado Caja	2006	2015	Bt 50 Pick-Up 2.5 4X4 (Hembra) Diesel	MT	L	NA	28	36	42	88.5	112	NA
Mazda	T143024KX	JM Lado Caja	2006	2015	Bt 50 Pick-Up 2.5 4X4 (Macho) Diesel	MT	R	NA	30	36	38	88.5	195.5	NA
Mazda	T144049KX	JM Lado Caja	2008	-	Bt 50 Diesel Derecho	MT	R	NA	30	36	38	94.5	101	NA
Mazda	T144050KX	JM Lado Caja	2008	-	Bt 50 Diesel Izquierdo	MT	L	NA	28	36	42	35.5	112	NA
Mazda	T144051KX	JM Lado Caja	1987	-	Bt 50 Antigua Derecho (Hembra) Gasolina	MT	R	NA	26	25	35	82.5	95.5	NA
Mazda	T144052KX	JM Lado Caja	1987	-	Bt 50 Antigua Derecho (Macho) Gasolina	MT	R	NA	26	25	35	82.5	108.5	NA
Mazda	T173422KX	Eje Homocinético	2006	2015	Bt 50 Pick-Up 2.5 4X4 Diesel	MT	R	44	28	30	61.4	91	577	NA
Mazda	T173423KX	Eje Homocinético	2006	2015	Bt 50 Pick-Up 2.5 4X4 Diesel	MT	L	44	28	28	61.4	91	492	NA
Mazda	T171803KX	Eje Homocinético	2008	-	Bt 50 Diesel Izquierdo Y Derecho	MT	L/R	NA	26	26	65	90	606	NA

#### BT-50 Gasolina

BT-50 Gasolina		Datos del producto			
----------------	--	--------------------	--	--	--

Datos del producto						Generales			Características Técnicas					
Marca	# Transejes®	Producto	Año Inicial	Año Final	Modelo	MT/AT	L/R	ABS	A	B	C	H	L	P
Mazda	T121829KX	JF Lado Rueda	2011	2017	Cx-5 (2.0 Y 2.5 6AT/6MT/ 2.0 Y 2.5 Awd)	MT/AT	L/R	NA	31	24	59,5	86,5	69	I
Mazda	T141820KX	JM Lado Caja	1991	1995	Mx-3	MT	L	NA	24	22	35	64	98,5	NA

## Mitsubishi

## Lancer

Datos del producto						Generales			Características Técnicas					
Marca	# Transejes®	Producto	Año Inicial	Año Final	Modelo	MT/AT	L/R	ABS	A	B	C	H	L	P
Mitsubishi	T121828KX	JF Lado Rueda	1993	-	Lancer	MT	L/R	NA	25	22	54	95	59,8	I
Mitsubishi	T122001KX	JF Lado Rueda	1993	-	Lancer 1.8/2.0	MT	L/R	NA	25	23	54	96	60	M
Mitsubishi	T122004KX	JF Lado Rueda	1987	1991	Lancer (C52A)	MT/AT	L/R	NA	25	22	50	96	57	M
Mitsubishi	T123681KX	JF Lado Rueda	2000	-	Lancer	Cvt	L/R	43	25	30	57	95	60,5	M
Mitsubishi	T123683KX	JF Lado Rueda	2003	-	Lancer	MT	L/R	43	25	30	54	95	60	I
Mitsubishi	T131802KX	Bota LC y LR	2003	-	Lancer	MT/AT	L/R	NA	NA	NA	NA	NA	NA	NA
Mitsubishi	T144065KX	JM Lado Caja	2003	2007	Lancer Cs W	MT	L/R	NA	25	30	35	47,5	101	NA
Mitsubishi	T144066KX	JM Lado Caja	2003	2007	Lancer Sedan	L/R	NA	NA	25	28	41	62,5	87,5	NA

## Mirage/Montero(Pajero y Sportero)

Datos del producto						Generales			Características Técnicas					
Marca	# Transejes®	Producto	Año Inicial	Año Final	Modelo	MT/AT	L/R	ABS	A	B	C	H	L	P
Mitsubishi	T122004KX	JF Lado Rueda	1987	1991	Mirage (C52A)	MT/AT	L/R	NA	25	22	50	96	57	M
Mitsubishi	T121827KX	JF Lado Rueda	1983	1992	Montero Pajero I 2.6 4Wd/Pajero Sport I 2.8 Tdi	MT	L/R	NA	28	27	56	154,5	63	I
Mitsubishi	T122002KX	JF Lado Rueda	1990	1999	Montero Pajero II 2.5/3.0 4WD	MT	L/R	NA	28	25	56	155,5	64	M
Mitsubishi	T122002KX	JF Lado Rueda	2000	2006	Montero Pajero Sport I 3.0/Nativa I 3.0	MT/AT	L/R	NA	28	25	56	155,5	64	M
Mitsubishi	T142001KX	JM Lado Caja	1990	2000	Pajero I (Montero)(2.5 Td Rh) Dia Pilot 69	MT/AT	R	NA	NA	25	-	-	68,6	NA
Mitsubishi	T142002KX	JM Lado Caja	1990	2000	Pajero I (Montero) (2.5 Td Lh)	MT/AT	L	NA	25	25	32	90,67	81,83	NA
Mitsubishi	T122003KX	JF Lado Rueda	1996	2007	Sportero L200 2.5 4X4 Diesel/Sport Gl Y GlS Hpe	MT	L/R	50T	30	33	66	98	67	I
Mitsubishi	T122005KX	JF Lado Rueda	2005	2016	Sportero L200(2.5 4Wd)	MT/AT	L/R	47	30	33	69	98,2	66,5	I
Mitsubishi	T142001KX	JM Lado Caja	1990	2000	Sportero L200 (2.5 Td Rh) Dia Pilot 69	MT/AT	R	NA	69	25	-	-	68,6	NA
Mitsubishi	T142002KX	JM Lado Caja	1990	2000	Sportero L200 (2.5 Td Lh)	MT/AT	L	NA	25	25	32	90,67	81,83	NA

## Triton

Datos del producto						Generales			Características Técnicas					
Marca	# Transejes®	Producto	Año Inicial	Año Final	Modelo	MT/AT	L/R	ABS	A	B	C	H	L	P
Mitsubishi	T122005KX	JF Lado Rueda	2005	2016	Triton (2.5/2.5 4Wd)	MT/AT	L/R	47	30	33	69	98,2	66,5	I

## Nissan

## Almera

Datos del producto						Generales			Características Técnicas					
Marca	# Transejes®	Producto	Año Inicial	Año Final	Modelo	MT/AT	L/R	ABS	A	B	C	H	L	P
Nissan	T122203KX	JF Lado Rueda	1996	-	Almera	MT/AT	L/R	NA	25	23	55	107	62	I
Nissan	T123675KX	JF Lado Rueda	1995	2000	Almera 1,4 (N15)	MT	L/R	NA	25	22	55	107	56	I
Nissan	T123676KX	JF Lado Rueda	1995	-	Almera	MT	L/R	42	25	22	55	107	56	I
Nissan	T123712KX	JF Lado Rueda	2003	-	Almera II 1.5	MT	L/R	NA	25	23	55	96,5	63,5	M
Nissan	T123713KX	JF Lado Rueda	2003	-	Almera II 1.5	MT	L/R	42	25	23	55	96,5	63,5	M
Nissan	T142200KX	JM Lado Caja	1995	2000	Almera (N15)	MT	L/R	NA	25	23	40	63	101	NA

## Frontier/Frontier NP300

Datos del producto						Generales			Características Técnicas					
Marca	# Transejes®	Producto	Año Inicial	Año Final	Modelo	MT/AT	L/R	ABS	A	B	C	H	L	P
Nissan	T122204KX	JF Lado Rueda	1998	2005	Frontier 2.5Td D22/NP300 D22 2.5 Dci	MT	L/R	NA	28	25	50	150	71	I
Nissan	T123647KX	JF Lado Rueda	2007	-	Frontier	MT/AT	L/R	NA	28	25	50	150	71	I
Nissan	T123648KX	JF Lado Rueda	1987	1998	Frontier D21 Pick Up 2.5 D 4WD	MT	L/R	NA	28	25	50	150	71	I
Nissan	T132400KX	Bota Lado Rueda	1998	2020	Frontier NP300 2.5 (D22)	MT	L/R	NA	NA	NA	NA	NA	NA	NA

## Interstar/March

Datos del producto						Generales			Características Técnicas					
Marca	# Transejes®	Producto	Año Inicial	Año Final	Modelo	MT/AT	L/R	ABS	A	B	C	H	L	P
Nissan	T122411KX	JF Lado Rueda	2002	2006	Interstar 2.5 Ferguson/ Autobus (X70) Dci 80	MT	L/R	51	28	36	65,2	95	166	I
Nissan	T123678KX	JF Lado Rueda	1999	-	March / Micra	MT/AT	L/R	NA	23	22	48	92,5	56,5	M

## Pathfinder

Datos del producto						Generales			Características Técnicas					
Marca	# Transejes®	Producto	Año Inicial	Año Final	Modelo	MT/AT	L/R	ABS	A	B	C	H	L	P
Nissan	T123648KX	JF Lado Rueda	1987	1998	Pathfinder I 2.4/3.0 4WD	MT	L/R	NA	27	27	50	150	71	I
Nissan	T123649KX	JF Lado Rueda	1990	-	Pathfinder 3.3	MT	L/R	NA	28	27	50	150	71	I

## Primera/Qashqai

Datos del producto						Generales			Características Técnicas					
Marca	# Transejes®	Producto	Año Inicial	Año Final	Modelo	MT/AT	L/R	ABS	A	B	C	H	L	P
Nissan	T144084KX	JM Lado Caja	1996	-	Primera Traveller	AT	L/R	NA	25	32	40	63	108	NA
Nissan	T123707KX	JM Lado Rueda	2006	-	Qashqai/Koleos	MT	L/R	NA	29	35	56,1	102	59	O
Nissan	T123708KX	JF Lado Rueda	2007	2013	Qashqai/Qashqai+2 1.6/2.0 4X4 Gasolina	MT	L/R	NA	29	36	56	102	72	I

## Sentra

Datos del producto						Generales			Características Técnicas					
Marca	# Transejes®	Producto	Año Inicial	Año Final	Modelo	MT/AT	L/R	ABS	A	B	C	H	L	P
Nissan	T122200KX	JF Lado Rueda	1990	2014	Sentra B12 Mex	MT	L/R	NA	25	22	52,2	97,5	55	I
Nissan	T122201KX	JF Lado Rueda	1993	-	Sentra 1.6 Wpb	MT	L/R	NA	25	24	52,3	107	62	I
Nissan	T122202KX	JF Lado Rueda	1993	-	Sentra B-12 Mexico	AT	L/R	NA	25	24	55	105	62	I
Nissan	T122203KX	JF Lado Rueda	1996	-	Sentra B13	MT/AT	L/R	NA	25	23	55	107	62	I
Nissan	T123711KX	JF Lado Rueda	1996	-	Sentra Hf / L	MT	L/R	NA	25	32	55	105	62	I
Nissan	T144082KX	JM Lado Caja	1987	-	Sentra 1.6	MT	L/R	NA	24	23	40	51,5	107,5	NA
Nissan	T144084KX	JM Lado Caja	1996	-	Sentra Hf	AT	L/R	NA	25	32	40	63	108	NA

## Sunny/Tiida

Datos del producto						Generales			Características Técnicas					
Marca	# Transejes®	Producto	Año Inicial	Año Final	Modelo	MT/AT	L/R	ABS	A	B	C	H	L	P
Nissan	T122200KX	JF Lado Rueda	1990	2014	Sunny B12 85-90	MT	L/R	NA	25	22	52,2	97,5	55	I
Nissan	T123675KX	JF Lado Rueda	1990	2000	Sunny Iii 1,4 / 1,6 / 2,0 (N14)	MT	L/R	NA	25	22	55	107	56	I
Nissan	T123677KX	JF Lado Rueda	1982	1986	Sunny B11 1,5 / 1,7 L	MT/AT	L/R	NA	24	22	52	105	56	I
Nissan	T123650KX	JF Lado Rueda	2008	-	Tiida 1.8	MT	L/R	NA	25	23	49,1	92	57	M
Nissan	T123710KX	JF Lado Rueda	2007	2011	Tiida 1.6 / 1.8	MT	L/R	NA	25	22	49	94	56	M

## X-Trail

Datos del producto						Generales			Características Técnicas					
Marca	# Transejes®	Producto	Año Inicial	Año Final	Modelo	MT/AT	L/R	ABS	A	B	C	H	L	P
Nissan	T123651KX	JF Lado Rueda	2002	2013	X-Trail I 4X4(2.2 01-05/2.2 01-08/2.5 02-13)	MT/AT	L/R	44	29	25	56	103,5	70,5	I

## Opel/Peugeot

Datos del producto						Generales			Características Técnicas					
Marca	# Transejes®	Producto	Año Inicial	Año Final	Modelo	MT/AT	L/R	ABS	A	B	C	H	L	P
Peugeot	T144086KX	JM Lado Caja	1998	-	206 1.4	-	L/R	NA	22	22	48	329,5	87,5	NA
Peugeot	T123639KX	JF Lado Rueda	1991	-	305	MT	L/R	NA	25	22	54,8	79	48	I
Peugeot	T144034KX	JM Lado Caja	1996	-	306	MT	R	NA	24	34	40	69	99	NA
Peugeot	T123208KX	JF Lado Rueda	1996	-	405 3.5	MT	L/R	NA	25	34	55	78,8	56,5	I
Peugeot	T123639KX	JF Lado Rueda	1991	-	405	MT	L/R	NA	25	22	54,8	79	48	I

## Renault

## Capture

Datos del producto						Generales		Características Técnicas					
Marca	# Transejes®	Producto	Año Inicial	Año Final	Modelo	MT/AT	L/R ABS	A	B	C	H	L	P
Renault	T123668KX	JF Lado Rueda	2013	-	Capture I Y II 1.2 MT /1.5 MT	MT	L/R NA	25	33	52.7	88.5	59.5	I

## Clio

Datos del producto						Generales		Características Técnicas					
Marca	# Transejes®	Producto	Año Inicial	Año Final	Modelo	MT/AT	L/R ABS	A	B	C	H	L	P
Renault	T122402KX	JF Lado Rueda	2004	-	Clio	MT	L/R NA	21	30	49.8	83.5	57.5	O
Renault	T122408KX	JF Lado Rueda	2007	-	Clio II Abs	MT	L/R 26	21	30	51.5	83	56.5	O
Renault	T123618KX	JM Lado Caja	2006	-	Clio	MT	L/R NA	23	21	36.4	35.8	83	NA
Renault	T142405KX	JM Lado Caja	2001	-	Clio II	MT	R NA	23	22	36	40	64.5	NA
Renault	T164002KX	Tripode Lado Caja	2006	-	Clio I Y Clio II (Logan I/Sandero/Stepwaymegane)	MT	L NA	22	NA	NA	NA	NA	NA
Renault	T172408KX	Eje Homocinético	1990	1998	Clio I 1.4	MT	L NA	21	29.95	49.8	83.5	610	NA
Renault	T172409KX	Eje Homocinético	1990	1998	Clio I 1.4	MT	R NA	21	23	49.8	81	698.5	NA
Renault	T175046KX	Bota Lado Rueda	2011	-	Clio III	MT	L/R NA	NA	NA	NA	NA	NA	NA
Renault	T175047KX	Eje Homocinético	2005	-	Clio Campus	MT	R NA	21	21	55	83.5	726 / 756	NA
Renault	T175048KX	Eje Homocinético	2005	-	Clio Campus	MT	L NA	21	29.95	55	83.5	628	NA

## Duster 4X2

Datos del producto						Generales		Características Técnicas					
Marca	# Transejes®	Producto	Año Inicial	Año Final	Modelo	MT/AT	L/R ABS	A	B	C	H	L	P
Renault	T123666KX	JF Lado Rueda	2010	2021	Duster 4X2 1.6/2.0	MT	L/R NA	25	33	52.6	89	60	I
Renault	T123668KX	JF Lado Rueda	2010	2021	Duster 4X2 2.0	AT	L/R NA	25	33	52.7	88.5	59.5	I
Renault	T132815KX	Bota Lado Rueda	2010	2021	Duster 4X2 1.6/2.0	MT	L/R NA	NA	NA	NA	NA	NA	NA
Renault	T132820KX	Bota Lado Caja	2010	2021	Duster 4X2 Rh	MT	L/R NA	NA	NA	NA	NA	NA	NA
Renault	T132821KX	Bota Lado Caja	2010	2021	Duster 4X2 Lh	MT	L/R NA	NA	NA	NA	NA	NA	NA
Renault	T144041KX	JM Lado Caja	2010	2021	Duster 4X2 Rh	MT	R NA	26	33	42.5	329	77	NA
Renault	T144042KX	JM Lado Caja	2010	2021	Duster 4X2 Lh	MT	L NA	26	33	40	64	118	NA
Renault	T175042KX	Eje Homocinético	2010	2021	Duster 4X2 1.6/2.0 Rh	MT	R NA	25	26	52.6	89	950 / 997	NA
Renault	T175044KX	Eje Homocinético	2010	2021	Duster 4X2 1.6/2.0 Lh	MT	L NA	25	26	52.6	89	704	NA
Renault	T1750423X	Eje Homocinético	2010	2021	Duster 4X2 2.0 Rh	AT	R NA	25	26	52.7	88.5	837 / 887	NA
Renault	T175045KX	Eje Homocinético	2010	2021	Duster 4X2 2.0 Lh	AT	L NA	25	26	52.7	88.5	710 / 760	NA

## Duster 4X4

Datos del producto						Generales		Características Técnicas						
Marca	# Transejes®	Producto	Año Inicial	Año Final	Modelo	MT/AT	L/R ABS	A	B	C	H	L	P	
Renault	T123731KX	JF Lado Rueda	2010	2021	Duster 4X4 1.6/2.0	MT/AT	L/R NA	25	35	52.6	89	60	I	
Renault	T132817KX	Bota Lado Rueda	2010	2021	Duster 4X4 1.6/2.0	MT	L/R NA	NA	NA	NA	NA	NA	NA	
Renault	T132822KX	Bota Lado Caja	2010	2021	Duster 4X4 Rh 1.6/2.0	MT	L/R NA	NA	NA	NA	NA	NA	NA	
Renault	T132823KX	Bota Lado Caja	2010	2021	Duster 4X4 Lh 1.6/2.0	MT	L/R NA	NA	NA	NA	NA	NA	NA	
Renault	T144043KX	JM Lado Caja	2010	2021	Duster 4X4 Rh 1.6/2.0	MT	R NA	26	33	42.5	216	77.5	NA	
Renault	T144044KX	JM Lado Caja	2010	2021	Duster 4X4 Lh 1.6/2.0	MT	L NA	26	33	43	46	76	NA	
Nuevo!!	Renault	T172414KX	Eje Homocinético	2010	2021	Duster 4X4 2.0 Rh	MT	R NA	25	29+2 Black	52.6	89	611/653	NA
Nuevo!!	Renault	T172415KX	Eje Homocinético	2010	2021	Duster 4X4 2.0 Lh	MT	L NA	25	27	52.6	89	652/689	NA
Renault	T123734KX	JF Lado Rueda	2010	2021	Duster 4x4 EJE TRASERO 2.0	MT/AT	L/R 48	25	28	52.25	89	60.5	I	

## Fluence/Kangoo/Koleos

Datos del producto						Generales		Características Técnicas					
Marca	# Transejes®	Producto	Año Inicial	Año Final	Modelo	MT/AT	L/R ABS	A	B	C	H	L	P
Renault	T123668KX	JF Lado Rueda	2012	-	Fluence (1.6 16V)	MT	L/R NA	25	33	52.7	88.5	59.5	I
Renault	T123609KX	JF Lado Rueda	2007	-	Kangoo	MT	L/R NA	23	23	57	83	61	M
Renault	T123732KX	JF Lado Rueda	2008	-	Koleos I (HY) 2.0 dCi 4x4	MT	L/R	29	35	56.1			I

## Logan

Datos del producto						Generales		Características Técnicas					
Marca	# Transejes®	Producto	Año Inicial	Año Final	Modelo	MT/AT	L/R ABS	A	B	C	H	L	P
Renault	T123610KX	JF Lado Rueda	2011	-	Logan	MT	L/R NA	21	21	49	83.5	57.5	M
Renault	T164001KX	Tripode Lado Caja	2011	-	Logan 1.4 / 1.6 Ecuador	MT	L/R NA	30	29.95	NA	NA	NA	NA
Renault	T164002KX	Tripode Lado Caja	2006	2011	Logan I (1.4 Y 1.6)	MT	L NA	22	NA	NA	NA	NA	NA
Renault	T172410KX	Eje Homocinético	2006	2010	Logan I (1.4 Y 1.6) /21 Dientes (24 Dientes Internos Junta Fija )	MT	R NA	21	23	49	84	765 - 795	NA
Renault	T172411KX	Eje Homocinético	2006	2010	Logan I (1.4 Y 1.6) /21 Dientes (24 Dientes Internos Junta Fija )	MT	L NA	21	29.95	49	84	681	NA
Renault	T173430KX	Eje Homocinético	2011	-	Logan 23 Dientes	MT	R NA	23	23	49	84	762 / 780	NA
Renault	T173431KX	Eje Homocinético	2011	-	Logan 23 Dientes	MT	L NA	23	29.95	49	84	680	NA
Renault	T175001KX	Eje Homocinético	2006	2010	Logan I (1.4 Y 1.6) 21 Dientes Diseño Spicer	MT	R NA	21	23	49	75	762	NA
Renault	T175002KX	Eje Homocinético	2006	2010	Logan I (1.4 Y 1.6) 21 Dientes Diseño Spicer	MT	L NA	21	29.95	49	75	680	NA

## Master

Datos del producto						Generales		Características Técnicas						
Marca	# Transejes®	Producto	Año Inicial	Año Final	Modelo	MT/AT	L/R ABS	A	B	C	H	L	P	
Nueva!!	Renault	T122411KX	JF Lado Rueda	1998	>>	Master II (Jd) 1.9 / 2.2 / 2.5 Dci Abs	MT	L/R 51	28	36	65.2	95	166	I
Renault	T122412KX	JF Lado Rueda	2010	>>	Master III - 2.3 Lt Sin Abs	MT	L/R NA	31	27	70	100	163.5	I	

## Megane

Datos del producto						Generales		Características Técnicas					
Marca	# Transejes®	Producto	Año Inicial	Año Final	Modelo	MT/AT	L/R ABS	A	B	C	H	L	P
Renault	T122407KX	JF Lado Rueda	1999	-	Megane (1.4/1.6) Abs	MT	L/R 44	21	30	51.5	83	56.5	O
Renault	T122409KX	JF Lado Rueda	1999	-	Megane 1.4	MT	L/R 44	21	22	51.5	83	56.5	I
Renault	T123611KX	JF Lado Rueda	2004	-	Megane II	MT	L/R NA	23	32	49	86	62	I
Renault	T123612KX	JF Lado Rueda	2003	2009	Megane II (2.0 16V/ Ranchera Familiar 2.0/Sedán 1,6 Y 2.0)	MT	L/R NA	23	33	49	86.5	61	I
Renault	T123668KX	JF Lado Rueda	2008	2015	Megane III (1.5 / 1.6 16V Coupe (Dz)(Kz))	MT	L/R NA	25	33	52.7	88.5	59.5	I
Renault	T123668KX	JF Lado Rueda	2016	-	Megane IV (1.5 Dci 110)	MT	L/R NA	25	33	52.7	88.5	59.5	I
Renault	T142405KX	JM Lado Caja	2001	-	Megane Nuevo Diseño	MT	R NA	23	22	36	40	64.5	NA
Renault	T164002KX	Tripode Lado Caja	2006	-	Megane	MT	L NA	22	NA	NA	NA	NA	NA
Renault	T175016KX	Eje Homocinético	1999	-	Megane (1.4 Y 1.6)	MT	R NA	21	23	49.8	83.5	698.5	NA
Renault	T175017KX	Eje Homocinético	1999	-	Megane (1.4 Y 1.6)	MT	L 44	21	29.95	57	84.5	545.7	NA
Renault	T175046KX	Bota Lado Rueda	2011	-	Megane (1.4 Y 1.6)	MT	L/R NA	NA	NA	NA	NA	NA	NA

## R-12

Datos del producto						Generales		Características Técnicas					
Marca	# Transejes®	Producto	Año Inicial	Año Final	Modelo	MT/AT	L/R ABS	A	B	C	H	L	P
Renault	T122405KX	JF Lado Rueda	1973	-	R-12	MT	L/R NA	20	30	48	107	57.5	O
Renault	T142400KX	JM Lado Caja	1973	-	R-12	MT	R NA	23	22	36.3	40	64.5	NA
Renault	T162400KX	Tripode Lado Caja	1983	-	R-9 / R12 / R18 /	MT	L/R NA	22	NA	NA	NA	NA	NA
Renault	T172402KX	Eje Homocinético	1973	-	R-12	MT	L/R NA	20	23	40	80.5	645	NA

## R-18/R-19

Datos del producto						Generales		Características Técnicas					
Marca	# Transejes®	Producto	Año Inicial	Año Final	Modelo	MT/AT	L/R ABS	A	B	C	H	L	P
Renault	T122404KX	JF Lado Rueda	1984	-	R-18 Ctx 2.0	MT	L/R NA	23	25	56.3	80.5	56	O
Renault	T122405KX	JF Lado Rueda	1973	-	R-18 Gtl	MT	L/R NA	20	30	48	107	57.5	O
Renault	T142400KX	JM Lado Caja	1973	-	R-18	MT	R NA	23	22	36.3	40	64.5	NA
Renault	T162400KX	Tripode Lado Caja	1983	-	R-9 / R12 / R18	MT	L/R NA	22	NA	NA	NA	NA	NA
Renault	T172403KX	Eje Homocinético	1973	-	R-18 Gtl	MT	L/R NA	23	23	48	107	666.5	NA
Renault	T172406KX	Eje Homocinético	1973	-	R-18 Gtl / Gtx 4 Pernos	MT	L NA	23	23	56.3	90	687	NA
Renault	T131851KX	Bota Lado Rueda	1983	-	R-19	MT	L/R NA	NA	NA	NA	NA	NA	NA







**Transporter**

Datos del producto						Generales			Características Técnicas					
Marca	# Transejes®	Producto	Año Inicial	Año Final	Modelo	MT/AT	L/R	ABS	A	B	C	H	L	P
Volkswagen	T123663KX	JF Lado Rueda	2003	2009	Transporter V T5 Autobús (1.9 Tdi)	MT	L/R	NA	38	27	63	102	66	M
Volkswagen	T123663KX	JF Lado Rueda	2011	2015	Transporter V T5 Autobús (2.0 Tdi)	MT	L/R	NA	38	27	63	102	66	M
Volkswagen	T123686KX	JF Lado Rueda	2003	2009	Transporter T5 (1.9 Tdi) / (2.0 Bitdi/4Motion) / (2.5 Tdi/4Motion) / (3.2 4Motion/V6)	MT	L/R	NA	38	27	63	102.5	66	M
Volkswagen	T144030KX	JM Lado Caja	2003	2015	Transporter V Furgón (1.9 Tdi/2.0)	MT	R	NA	26	28	50	205	63	NA
Volkswagen	T144033KX	JM Lado Caja	2003	2015	Transporter V Furgón (1.9/2.0 Tdi)	MT	L	NA	NA	28	108	32	NA	NA
Volkswagen	T175040KX	Eje Homocinético	2009	2015	Transporter (Caravelle Vi 2.0 / V 2.0 /V Furgon 1.9, 2.0 /Vi Furgón 2.0 )	MT	L	NA	38	D2 108	63	102.5	645	NA

# ***Ejes Homocinéticos y sus Componentes***

**TRANSEJES<sup>®</sup>**  
**TE RESPALDA SIEMPRE!**

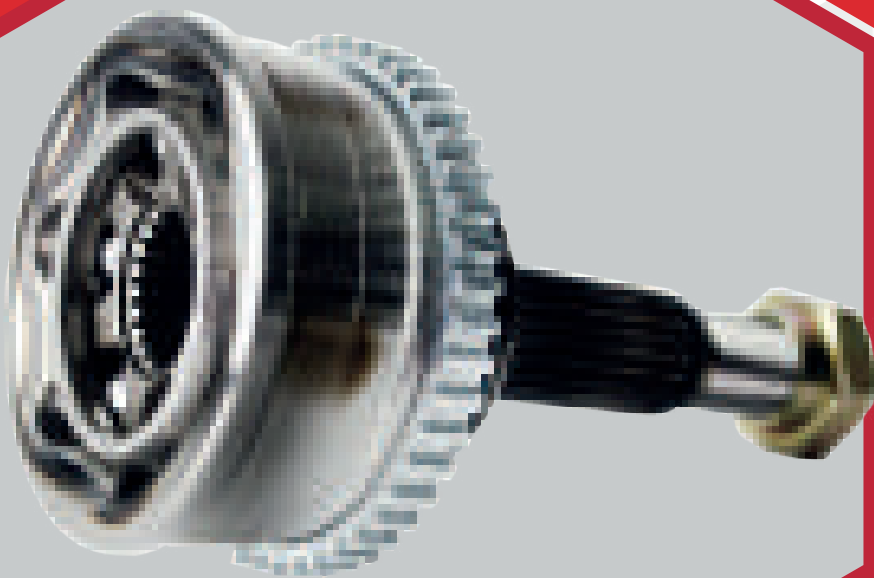

Servicio al cliente 01 8000117444  
E-mail: [servico.cliente@dana.com](mailto:servico.cliente@dana.com)  
Consulte nuestra red de distribuidores  
Línea de WhatsApp Business: +57 3134637685  
a través de nuestro sitio web: [transejes.com/componentes-automotrices/](http://transejes.com/componentes-automotrices/)

©2023-01 Dana limited

